









PLUS+[®]
PLUSTCOLLECTION

PLUS+[®]
PLUSTCOLLECTION

FURNITURE

Airball Armchair	64
Airball Sofa	65
Armillaria Stool	10
Armillaria Table	11
Bartolomeo Corner	15
Bartolomeo Desk	14
Bartolomeo Display	16
Big Cut Armchair	20
Big Cut Corner	22
Big Cut Module	23
Big Cut Pouf	24
Big Cut Table	25
Bold Armchair	28 
Bold Sofa	28 
Bold Table	29 
Enta	53
Frozen Chair	42
Frozen Corner	33
Frozen Desk	32
Frozen Display	34 
Frozen Dining Table	43
Frozen Square Stool	40 
Frozen Stool	38
Frozen Table	39
Fura Stool	46
Fura Table	47
Fuzzy Stool	48
Goen	52
Gumball Armchair	56
Gumball Armchair Junior	67
Gumball Sofa	58
Gumball Sofa Junior	68
Gumball Sunlounge	60
Jetlag	74
Jetlag Chair	75
Mini Plust Van	70 
Ohla Armchair	78
Ohla Sofa	79
Planet Chair	82
Planet Table	83
Plust Van	70 
Sat	84
Simple Chair	88
Simple Table	89
T Ball	62
Talea Bench	93
Talea Chair	92







POTS

Boyo	96
Buba	98
Cactus	100
Cubalibre	102
Diamond	104
Drop	106
Fuzzy Pot	108
Giotto	110
Halful	112
Harbo	114
Humprey	116
Madame	118
Max	110
Mini Rebelot	130
Moai	120
More	122
Nicole	124
Ninfea	126
Rà	128
Rebelot	130
Renè	110
Reverse	132
Roo	134
Saving/Space/Vase	136
Sepio	138
Shock	140
Tambo	142
T Ball Pot	144
Tonqua	146
Trottola	148

ACCESSORIES

Baddy	152
Biggie	154 
Draghetto	156
Drago	156
Flower	164
Godot	158
Gradient 160	160
Gradient 180	160
Lapsus	162
Leaf	164
Mini Baddy	152
Moon-Leaves 1	166
Moon-Leaves 2	166

LIGHTS

Airball Armchair Light	226
Airball Sofa Light	227
Baddy Light	170
Bartolomeo Corner Light	175
Bartolomeo Desk Light	174
Bartolomeo Display Light	176
Big Cut Armchair Light	180
Big Cut Corner Light	182
Big Cut Module Light	183
Biggie Light	184 
Boyo Light	190
Bold Armchair Light	188 
Bold Sofa Light	188 
Bold Table Light	189 
Buba Light	192
Cubalibre Light	194
Cubalibre Table Light	196
Draghetto Light	198
Drago Light	198
Drop Light	200
Four Lamp Light	212 
Frozen Corner Light	205
Frozen Desk Light	204
Frozen Dining Table Light	209
Frozen Display Light	206 
Frozen Lamp Light	210 
Frozen Table Light	208
Fura Stool Light	216
Fura Table Light	217

Godot Light	218
Gumball Armchair Light	220
Gumball Sofa Light	222
Harbo Light	228
Horn Light	230
Humprey Light	232
Ice-Cap Light	234
Jetlag Light	238
Jetlag Chair Light	239
Mini Baddy Light	170
Mini Rebelot Light	248
Nicole Light	240
Ohla Armchair Light	244
Ohla Sofa Light	245
Rebelot Light	249
Roaming Light	250
Roo Light	252
Saving/Space/Vase Light	254
Spot Light	256
T Ball Light	224
Trim Light	258

TECHNICAL DATA

ACCESSOR	pag. 276
DESIGNER	pag. 300
FINITURE / FINISHINGS	pag. 262
KIT LUCE / LIGHT KIT	pag. 284
LIGHTING COLOURS	pag. 283
MANUTENZIONE / MAINTENANCE	pag. 274
OVERMEW	pag. 290
RGB LED Light	pag. 282



PLUS+
PLUSTCOLLECTION

IN/OUT DOOR COLLECTION

PLUST Collection nasce nel 2006 come design brand di euro3plast spa, azienda leader nella realizzazione di vasi e accessori in plastica distribuiti in tutto il mondo, che vanta un sistema di gestione certificato ed una produzione interamente Made in Italy.

Guidato dall'art direction dello studio JoeVelluto (JVLT), PLUST Collection sviluppa insieme a importanti firme nazionali e internazionali sistemi di prodotto che comprendono e risolvono le diverse necessità degli spazi indoor e outdoor.

Complementi d'arredo, oggetti luminosi e vasi arredano spazi indoor e outdoor amplificando gli usi, rispettando le funzioni e incoraggiando la socialità.

La produzione interna permette di indagare continuamente la materia plastica e le sue tecnologie di lavorazione, assicurando quindi un continuo miglioramento della qualità e lo sviluppo di prodotti innovativi che esaudiscono le richieste sia del contract, grazie anche ad un sistema di servizi dedicato, che del privato.

I prodotti PLUST Collection sono stampati con la tecnologia del rotomoulding: la qualità della lavorazione, le nuove tecniche e il rispetto per l'ambiente hanno permesso di ottenere le certificazioni per i migliori standard di garanzia e sicurezza, nonché riconoscimenti per gli innovativi sistemi di produzione.

Per PLUST Collection la versatilità di un prodotto è la sua essenza, la resistenza è affidabilità, la leggerezza è comodità, l'estetica è piacere.

PLUST Collection was launched in 2006 as a design brand of euro3plast spa, a leading manufacturer of vases and plastic accessories distributed worldwide. The company boasts a certified management system and all its products are Made in Italy.

Under the art direction of JoeVelluto (JVLT) design studio and in collaboration with renowned national and international designers, PLUST Collection develops systems that meet the various requirements of indoor e outdoor spaces.

Furnishes, luminous objects, and vases decorate indoor and outdoor spaces whilst enhancing their functions and promoting sociability.

The in-house manufacturing process allows for continuous investigation of plastic and its processing technologies, thereby ensuring the highest quality and the development of innovative products that meet the requirements of both contract furniture suppliers (thanks to tailor-made services) and private customers.

PLUST Collection products are made with the rotomoulding technique. High quality machining and respect for the environment have allowed PLUST Collection to obtain certifications, which guarantee that the highest quality and safety standards are met, as well as important recognitions for its innovative production systems.

For PLUST Collection, the essence of a product lies in its versatility. Wear resistance is reliability, lightness is comfort, and aesthetics is pleasure.



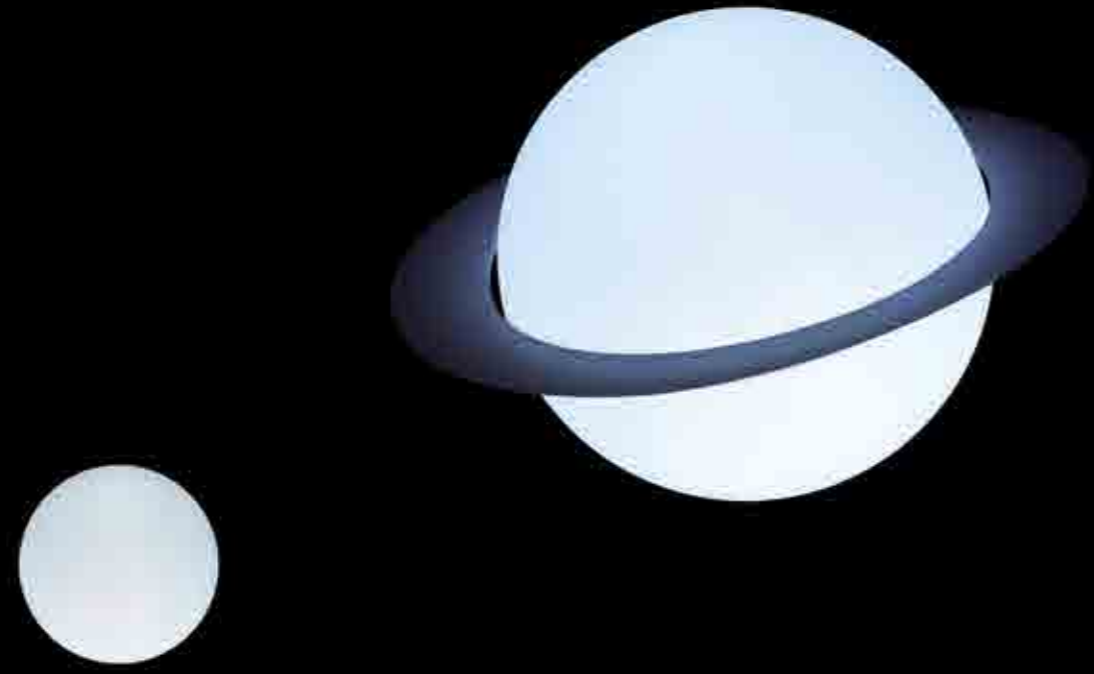

FURNITURE



ARMILLARIA FAMILY

DESIGN
ODOARDO FIORAVANTI



ARMILLARIA STOOL

DESIGN
ODOARDO FIORAVANTI
2010



Una famiglia di prodotti nasce da una radice comune da cui si ri-producono e spuntano forme diverse che assolvono alle singole funzioni, così i pezzi di questa serie condividono una base da cui germogliano. "Armillaria Stool" è uno sgabello realizzato in rotomoulding, disponibile in svariati colori e particolarmente adatto a spazi pubblici e contract.

A family of products stems from a common root from which re-sprout and produce different forms that perform individual functions, so the pieces of this series share a base from which to sprout. "Armillaria Stool" is a stool made in rotomoulding, available in several colors. Especially suitable for public spaces and contract.

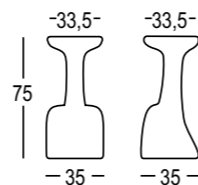

COLORI BASE / BASIC COLOURS

Art. 6249 | ARMILLARIA STOOL

- C2
- C9
- G9
- N4
- 69
- 87

ARMILLARIA TABLE

DESIGN
ODOARDO FIORAVANTI
2010



Tavolo a base centrale in polietilene stampato in rotomoulding. Abbinato ad un piano in materiali e finiture diverse, assume stili e connotazioni sempre nuovi.

Table with central polyethylene base. Paired with top materials and different finishings, it takes on new styles and connotations.

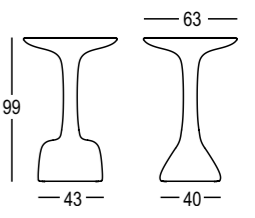

STRUCTURE

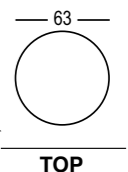

TOP

COLORI BASE / BASIC COLOURS

Art. 6250 | ARMILLARIA TABLE

- C2
- C9
- G9
- N4
- 69
- 87

PIANO / TOP

Ø 63 - Art. A4260

PE - Polietilene / Polyethylene

- C2
- 69

- C9 **Solo per INDOOR.** Si consiglia l'uso indoor. In ambiente outdoor non esporre direttamente alla luce solare.
- G9 **Only INDOOR.** We recommend indoor use. In the outdoor environment avoid directly solar light exposure.
- N4
- 87

PIANO / TOP

Ø 63 - Art. A4262

Legno / Wood*

*Destinato all'utilizzo in ambiente esterno coperto. Non esporre alle intemperie.

*Intended for use in covered outdoor environments. Do not expose to the elements.

BARTOLOMEO

FAMILY

DESIGN
JOEVELLUTO (JVL)





Versione **light** /
Light version

BARTOLOMEO DESK

DESIGN
JOEVELLUTO (JVL)
2013



Banco bar modulare dalla morbida linea estetica, solido e di facile manutenzione. Predisposto per accogliere 5 mensole di stoccaggio, presenta 3 nicchie per l'utilizzo operativo ed è predisposto per un piano di copertura. Permette di creare infinite soluzioni strutturali: postazioni reception, banconi lineari e piano alto per buffet. La gamma completa di accessori bar e la versione Light, lo rendono un prodotto versatile e adatto all'uso sia indoor che outdoor.

A solid, easy-maintenance modular bar counter with a smooth design. It can contain 5 shelves and has 3 niches. It is designed to enable the installation of a countertop. It allows the creation of infinite structural solutions: reception desks, linear bar counters, and buffet consoles. The full range of bar accessories and its Light version makes "Bartolomeo" a versatile product for indoor and outdoor use.

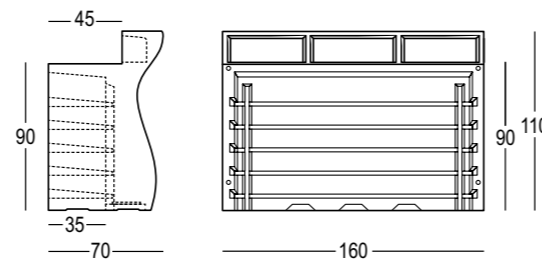

**COLORI BASE /
BASIC COLOURS**

- Art. 6277 | BARTOLOMEO DESK
- Art. 6286 | BARTOLOMEO DESK VERSION 1
- Art. 6287 | BARTOLOMEO DESK VERSION 2
- Art. 6288 | BARTOLOMEO DESK VERSION 3

C2

BARTOLOMEO CORNER

DESIGN
JOEVELLUTO (JVL)
2013



Versione **light** /
Light version



Elemento angolare che può essere utilizzato da solo o in coppia per creare piccoli desk di accoglienza. Facile da spostare, resistente agli urti, predisposto per un top di copertura, presenta 4 nicchie di stoccaggio, più 2 nicchie sul piano d' appoggio per l'utilizzo operativo. Abbinato all'elemento lineare svolge funzione di raccordo per infinite soluzioni dimensionali.

Corner element that can be used alone or paired to create small reception desks. "Bartolomeo Corner" is easy to move, impact-resistant, and designed to enable the installation of a countertop. It has 4 storage niches, plus other 2 on the worktop. Matched with the linear element it creates infinite dimensional solutions.

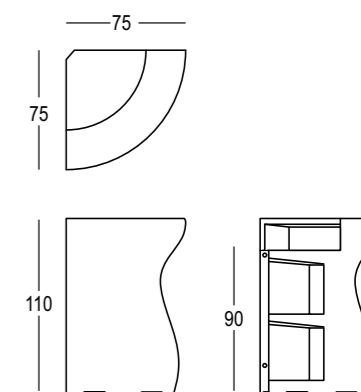

**COLORI BASE /
BASIC COLOURS**

- Art. 6278 | BARTOLOMEO CORNER

C2



BARTOLOMEO DISPLAY

DESIGN
JOVELLUTO (JVL)
2014



Versione **light** /
Light version



Display freestanding, adatto ad alloggiare bottiglie e strumenti utilizzati nell'ambito della ristorazione-bar. Utilizzato singolarmente, può diventare un elemento da arredo da utilizzare come libreria e/o contenitore. Disponibili anche 4 gambe in alluminio da fissare alla struttura, per avere le mensole ad un maggiore livello operativo.

Freestanding display for storing bottles and catering utensils. Used alone it can be also used as a bookcase and/or container. Also available with 4 aluminium legs to fasten to the structure to have the shelves at a higher position.

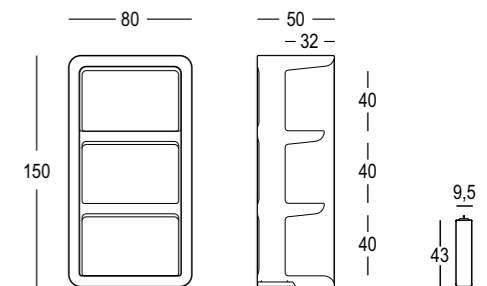

**COLORI BASE /
BASIC COLOURS**

Art. 6289 | BARTOLOMEO DISPLAY

C2

KIT GAMBE / LEGS KIT

Art. A4485

C2

BIG CUT FAMILY

DESIGN
MATALI CRASSET





BIG CUT ARMCHAIR

DESIGN
MATALI CRASSET
2013



Versione light /
Light version



Comoda poltrona con braccioli che rappresenta l'elemento principale del sistema "Big Cut", completa di un morbido cuscino, perfetto sia per ambienti indoor che outdoor. Un "taglio a V" è il denominatore comune che caratterizza e unisce ogni elemento del sistema, creando un family feeling estetico e funzionale, ideale per ambienti contract dinamici.
PER MAGGIORI INFORMAZIONI SUI CUSCINI: vedi sezione tecnica pag. 270

This comfortable armchair represents the main element of the "Big Cut" system. Its soft cushion makes it perfect both for outdoor and indoor use. The "V cut" is the common denominator of all the elements of the system, which creates a cosy yet functional space, ideal for dynamic contract furniture settings. FOR FURTHER INFORMATION ON THE CUSHIONS: see technical data section. 270

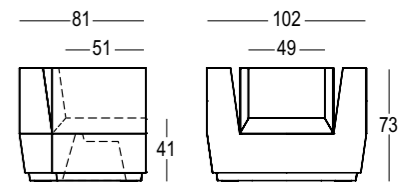

COLORI BASE / BASIC COLOURS

Art. 6279 | BIG CUT ARMCHAIR
Ecopelle / Sky

- L6
- M6
- P9

COLORI BASE / BASIC COLOURS

Art. 6279 | BIG CUT ARMCHAIR
Tessuto tecnico / Technical fabric

- L7
- L8
- M7
- M8
- Q0
- Q1



Versione light /
Light version

BIG CUT CORNER

DESIGN
MATALI CRASSET
2013

BIG CUT MODULE

DESIGN
MATALI CRASSET
2013



Versione light /
Light version

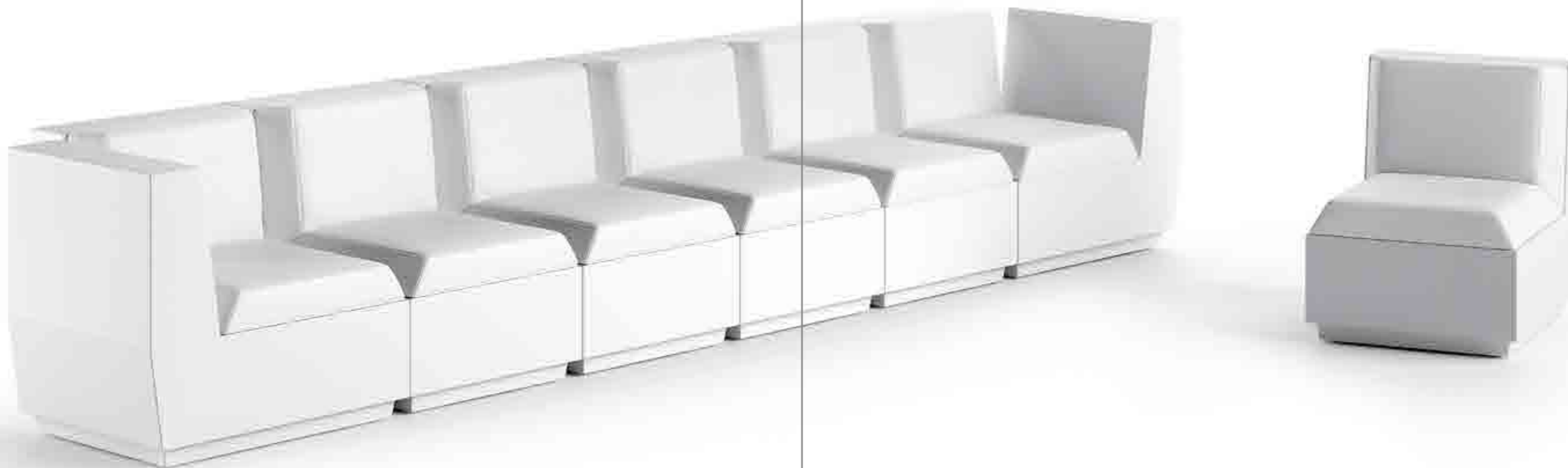

Elemento angolare adatto ad essere posto alle estremità di una composizione di moduli al fine di creare infinite soluzioni con il numero di posti a sedere necessario. Completo di cuscino adatto sia all'indoor che all'outdoor. A seconda dell'utilizzo, spostando il cuscino, si può ottenere un angolo destro o sinistro. PER MAGGIORI INFORMAZIONI SUI CUSCINI: vedi sezione tecnica pag. 270

This corner element can be placed at the end of the modular composition to create infinite solutions, always with the right number of seats. Provided with a cushion suitable for both indoor and outdoor use. You can arrange the cushion to obtain a right or left corner, according to requirements. FOR FURTHER INFORMATION ON THE CUSHIONS: see technical data section. 270

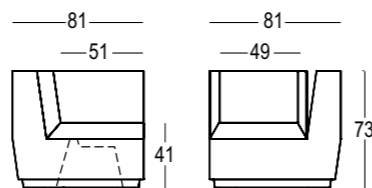

COLORI BASE / BASIC COLOURS

Art. 6281 | BIG CUT CORNER

Ecopelle / Sky

L6

M6

P9

COLORI BASE / BASIC COLOURS

Art. 6281 | BIG CUT CORNER

Tessuto tecnico / Technical fabric

L7

L8

M7

M8

Q0

Q1

Modulo senza braccioli che può essere utilizzato singolarmente o accostato ad uno o più elementi della famiglia "Big Cut". Abbinato a "Big Cut Corner" genera un divano dalla proporzione lineare desiderata. Completo di cuscino adatto sia all'indoor che all'outdoor. PER MAGGIORI INFORMAZIONI SUI CUSCINI: vedi sezione tecnica pag. 270

Module without arms that can be used alone or in combination with other elements of the "Big Cut" family. Combine it with "Big Cut Corner" to create a sofa with the desired proportions. Provided with a cushion suitable for both indoor and outdoor use. FOR FURTHER INFORMATION ON THE CUSHIONS: see technical data section. 270

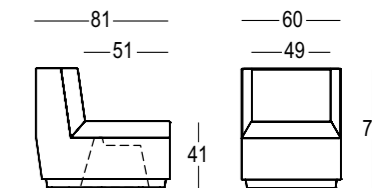

COLORI BASE / BASIC COLOURS

Art. 6280 | BIG CUT MODULE

Ecopelle / Sky

L6

M6

P9

COLORI BASE / BASIC COLOURS

Art. 6280 | BIG CUT MODULE

Tessuto tecnico / Technical fabric

L7

L8

M7

M8

Q0

Q1

BIG CUT POUF

DESIGN
MATALI CRASSET
2013



BIG CUT TABLE

DESIGN
MATALI CRASSET
2013



Accostato agli elementi di "Big Cut" family funge da comodo poggiatesta creando isole e soluzioni diversificate di composizioni. Utilizzato singolarmente o in più pezzi accostati è possibile ricreare delle libere sedute informali. Completo di cuscino adatto sia all'indoor che all'outdoor.
PER MAGGIORI INFORMAZIONI SUI CUSCINI: vedi sezione tecnica pag. 270

Combined with the other elements of the "Big Cut" family it can serve as a comfortable footrest or it can be used to create islands and various compositions. Use it alone or combined with other pieces to create informal seats. Provided with a cushion suitable for both indoor and outdoor use.
FOR FURTHER INFORMATION ON THE CUSHIONS: see technical data section. 270

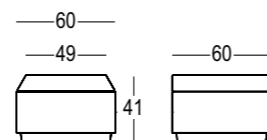

COLORI BASE / BASIC COLOURS

Art. 6285 | BIG CUT POUF

Ecopelle / Sky

- L6
- L9
- M6
- P9

COLORI BASE / BASIC COLOURS

Art. 6285 | BIG CUT POUF

Tessuto tecnico / Technical fabric

- L7
- L8
- M0
- M1
- M7
- M8
- Q0
- Q1

Coffee table che può essere utilizzato singolo o integrato all'interno del sistema di sequenza modulare "Big Cut" attraverso un pratico sistema di fissaggio posto sul fondo.

This coffee table can be used alone or integrated into the "Big Cut" modular system, thanks to the practical fastening system at the bottom.

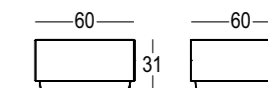

COLORI BASE / BASIC COLOURS

Art. 6282 | BIG CUT TABLE

- C2
- G9
- N4
- 98

**BOLD
FAMILY**
DESIGN
GIULIO IACCHETTI





Versione light /
Light version



Versione light /
Light version

BOLD ARMCHAIR BOLD SOFA

DESIGN
GIULIO IACCHETTI
2016



Poltrona e divano da due/tre posti caratterizzati da una seduta ampia e profonda completata da un sistema di cuscini che li rende molto comodi e accoglienti. I cuscini sono disponibili in tre nuance colore, e la loro costruzione con imbottitura in Dryfeel e fodera in tessuto Sunbrella, rendono gli articoli adatti all'utilizzo sia in ambiente indoor sia outdoor.

PER MAGGIORI INFORMAZIONI SUI CUSCINI: vedi sezione tecnica pag. 272

Two/three seat armchair and sofa with broad and deep seat, completed with a system of cushions that makes them comfortable and cosy. The cushions are available in three colours and their manufacture, with DryFeel upholstery and Sunbrella fabric lining, make these items ideal for use both indoors and out. FOR FURTHER INFORMATION ON THE CUSHIONS: see technical data section. 272

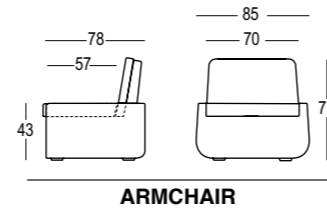

ARMCHAIR

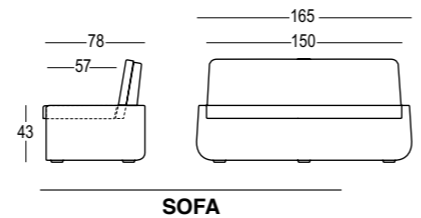

SOFA

COLORI BASE / BASIC COLOURS	COLORI BASE / BASIC COLOURS	COLORI BASE / BASIC COLOURS
Art. 6345 BOLD ARMCHAIR Art. 6348 BOLD SOFA Struttura / Structure	Art. 6346 BOLD ARMCHAIR Art. 6349 BOLD SOFA Struttura / Structure	Art. 6347 BOLD ARMCHAIR Art. 6350 BOLD SOFA Struttura / Structure
C2	C2	C2
G9	G9	G9
N4	N4	N4
34	34	34
TESSUTO / FABRIC	TESSUTO / FABRIC	TESSUTO / FABRIC
White 	Mink Brown 	Heather Grey

BOLD TABLE

DESIGN
GIULIO IACCHETTI
2016

Coffe table che si abbina e completa la famiglia di arredi "Bold". Il piano di appoggio è costituito da un piano in HPL (disponibile nelle colorazioni bianco e nero) che viene fissato sulla struttura di base in polietilene. Ideale per creare uno spazio conviviale.

Coffee table that matches and completes the "Bold" furnishings family. The top is made an HPL surface (available in black and white) which is fixed on the polyethylene base-frame. Ideal for creating a convivial area.

COLORI BASE / BASIC COLOURS	PIANO HPL / HPL TOP
Art. 6344 BOLD TABLE	Rotondo / Round
C2	Ø 60 - Art. A4463
G9	
N4	Ø 60 - Art. A4464
34	

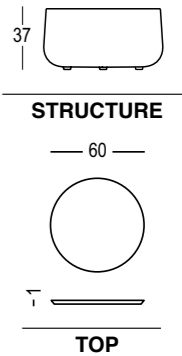

STRUCTURE

TOP

FROZEN FAMILY

DESIGN
MATTEO RAGNI + MAURIZIO PRINA





Versione light /
Light version

FROZEN DESK

DESIGN
MATTEO RAGNI +
MAURIZIO PRINA
2015



Bancone bar modulare disponibile in due conformazioni di profondità, per poter offrire un piano di lavoro più ampio in cui collocare macchine da caffè o altri elettrodomestici da appoggio. Nel vano inferiore possono trovare alloggio banchi frigo ed elettrodomestici da incasso. La sfaccettatura superficiale che lo caratterizza, "maschera" le linee di giunzione dei vari moduli rendendo le combinazioni uniformi e continuative. Il bancone "Frozen" è adatto all'utilizzo sia indoor che outdoor, è disponibile anche in versione luminosa e presenta una gamma completa di accessori bar.

This modular bar counter is available in two depths to provide a larger worktop where to place the coffee machine or other similar appliances. The lower compartment can house cold storage units and built-in appliances. The distinctive faceted surface "covers" the joints between the modules allowing for uniform and consistent combinations. The "Frozen" counter is suitable for indoor and outdoor use and is also available in the luminous version. Equipped with a full range of bar accessories.

COLORI BASE / BASIC COLOURS

- Art. 6308 | FROZEN DESK
- Art. 6320 | FROZEN DESK VERSION 1
- Art. 6321 | FROZEN DESK VERSION 2
- Art. 6316 | FROZEN DESK LARGE

C2

N4

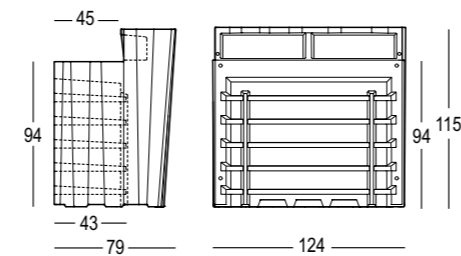

FROZEN

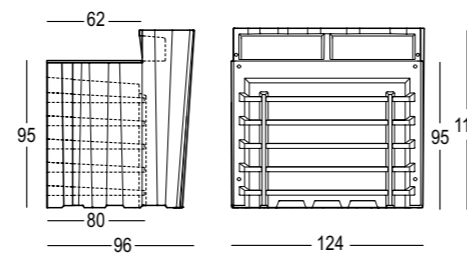

FROZEN LARGE

FROZEN CORNER

DESIGN
MATTEO RAGNI +
MAURIZIO PRINA
2015



Versione light /
Light version



Elemento angolare che può essere utilizzato da solo o in coppia per creare consolle o desk di accoglienza. Facile da spostare, resistente agli urti, predisposto per 5 mensole, un top superiore e è munito di 2 nicchie sul piano d'appoggio per l'utilizzo operativo. Abbinato all'elemento lineare svolge funzione di raccordo per creare banconi bar o reception desks.

A corner element that can be used alone or paired to create consoles or reception desks. "Frozen Corner" is easy to move and impact-resistant. It can have up to 5 shelves, a worktop and has 2 niches. Matched with the linear element, "Frozen Corner" can be used to create bar counters or reception desks.

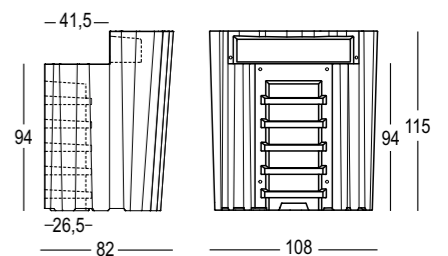
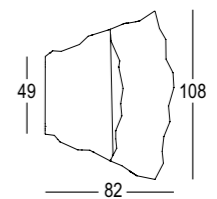

COLORI BASE / BASIC COLOURS

- Art. 6309 | FROZEN CORNER

C2

N4



FROZEN DISPLAY

DESIGN
MATTEO RAGNI +
MAURIZIO PRINA
2016



Versione **light** /
Light version



È un elemento free standing modulare, perfetto alleato del bancone bar, adatto per organizzare lo spazio nell'ambiente di lavoro della ristorazione/bar. I fianchi del display sono fortemente caratterizzati dalle tipiche sfaccettature "Frozen" dimostrando carattere, flessibilità e family feeling. I moduli display sono sormontabili su due livelli e affiancabili tra di loro.

Is a free-standing modular item which is ideal to put beside the bar, and to use for optimizing space in bar and catering contexts. The sides of the display are well characterized by typical "Frozen" facets, showing off character, flexibility and a family feeling. The display modules are surmountable on two levels and tileable.

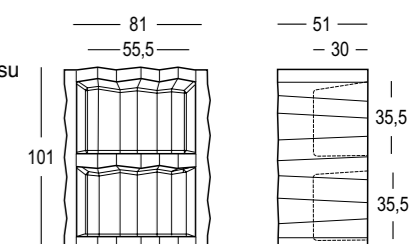

COLORI BASE / BASIC COLOURS

Art. 6338 | FROZEN DISPLAY

C2

N4

FROZEN FAMILY

DESIGN
MATTEO RAGNI + MAURIZIO PRINA



FROZEN STOOL

DESIGN
MATTEO RAGNI +
MAURIZIO PRINA
2015



Sgabello da bar adatto sia all'indoor che all'outdoor. Può essere accostato a tavoli alti e banconi bar. Solido e funzionale, risulta essere una seduta comoda, esteticamente versatile e facile da spostare.

Bar stool for both indoor and outdoor use. It can be paired with high tables and bar counters. This solid and functional stool is comfortable, versatile, and easy to move.

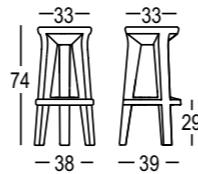

COLORI BASE / BASIC COLOURS

Art. 6313 | FROZEN STOOL

- C2
- M9
- N2
- N4
- 16
- 34
- 87

FROZEN TABLE

DESIGN
MATTEO RAGNI +
MAURIZIO PRINA
2015



Solido tavolo alto da bar a base centrale, abbinabile a piani in HPL di diverse dimensioni e colori. Disponibile anche in versione illuminata.

A solid high bar table with a central base, which can be matched with HPL tops in various sizes and colours. Luminous version also available.

COLORI BASE / BASIC COLOURS

Art. 6310 | FROZEN TABLE

- C2
- M9
- N2
- N4
- 16
- 34
- 87

PIANO / TOP

HPL - Rotondo / Round

- Ø 60 - Art. A4463
- Ø 70 - Art. A4490



- Ø 60 - Art. A4464
- Ø 70 - Art. A4491



HPL - Quadrato / Square

- 60x60 - Art. A4468
- 70x70 - Art. A4488



- 60x60 - Art. A4469
- 70x70 - Art. A4489



HPL - Rettangolare / Rectangular

- 180x60 - Art. A4470



- 180x60 - Art. A4471

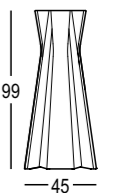

STRUCTURE

60 70

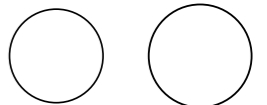

60 70

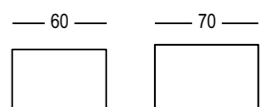

60 70

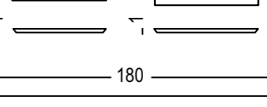

180 60

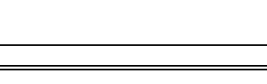

TOP



FROZEN SQUARE STOOL

DESIGN
MATTEO RAGNI +
MAURIZIO PRINA
2016



Versione a quattro gambe dello sgabello "Frozen". Stabile e solido sui quattro appoggi è un bilanciato gioco di equilibri tra forme morbide e nette sfaccettature.

Four-legged version of the "Frozen" stool. Stable and sturdy on all four legs, it is a balanced play of soft and sharper shapes.

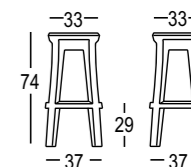

COLORI BASE / BASIC COLOURS

Art. 6342 | FROZEN SQUARE STOOL

C2

M9

N2

N4

16

34

87

FROZEN CHAIR

DESIGN
MATTEO RAGNI +
MAURIZIO PRINA
2015



Poltroncina confortevole, adatta all'uso indoor e outdoor, dotata di foro di scolo utilizzabile anche come punto di presa per spostarla agevolmente. Caratterizzata da una superficie fortemente geometrica, disponibile in svariate versioni colore, arreda con personalità qualsiasi ambiente.

A comfortable armchair suitable for indoor and outdoor use and equipped with a drain hole, which can also be used as a grasp point to move it around easily. "Frozen Chair" stands out for its geometric design and is available in various colours to add character to any setting.

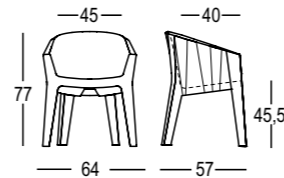

COLORI BASE / BASIC COLOURS

Art. 6312 | FROZEN CHAIR

- C2
- M9
- N2
- N4
- 16
- 34
- 87

FROZEN DINING TABLE

DESIGN
MATTEO RAGNI +
MAURIZIO PRINA
2015



Versione **light** /
Light version

Dining table a base centrale abbinato a piani in HPL di diverse dimensioni e colori. È adatto ad arredare ambienti bar e sale ristorante. La struttura base in polietilene può essere illuminata per creare effetti scenografici nell'allestimento sala.

Dining table with a central base matched with HPL tops in various sizes and colours. Suitable for both bars and restaurants. The polyethylene base structure can light up to create scenographic effects.

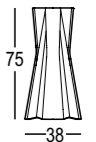

COLORI BASE / BASIC COLOURS

Art. 6311 | FROZEN DINING TABLE

- C2
- M9
- N2
- N4
- 16
- 34
- 87

PIANO / TOP

HPL - Rotondo / Round

- Ø 80 - Art. **A4494**
- Ø 100 - Art. **A4498**



- Ø 80 - Art. **A4495**
- Ø 100 - Art. **A4499**



HPL - Quadrato / Square

- 80x80 - Art. **A4492**
- 100x100 - Art. **A4496**



- 80x80 - Art. **A4493**
- 100x100 - Art. **A4497**



STRUCTURE

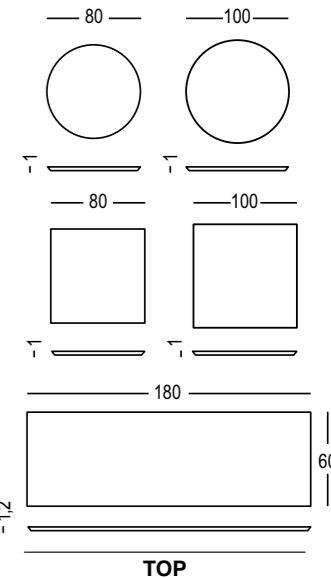

TOP

FURA FAMILY

DESIGN
FORM US WITH LOVE





Versione light /
Light version

FURA STOOL

DESIGN
FORM US WITH LOVE
2014

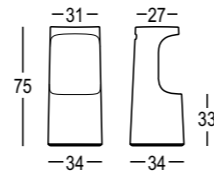

Sgabello dalla linea pulita ed essenziale, la cui linearità viene interrotta da una rientranza per l'alloggio dei piedi, che rievoca il taglio della lavorazione di un tronco, "Fura" in lingua svedese per l'appunto. Sul retro una maniglia agevola lo spostamento dello sgabello che viene completato dal tavolo coordinato "Fura Table".

A stool with clean-cut lines interrupted by a recess that serves as a footrest, which brings to mind the cutting of a tree trunk, "Fura" in Swedish. A handle on the rear makes it easy to move. The stool is matched with the "Fura Table".

COLORI BASE / BASIC COLOURS

Art. 6294 | FURA STOOL

- C2
- L4
- M9
- N2
- 87

FURA TABLE

DESIGN
FORM US WITH LOVE
2014



Versione light /
Light version



Tavolo totemico abbinato allo sgabello "Fura Stool". La base conica permette una buona stabilità e il piano in HPL lo rende un prodotto durevole nel tempo, facile da pulire e adatto a qualsiasi bar o locale in contesto indoor e outdoor.

Table matched with the "Fura Stool". Its conical base gives it extra stability and the HPL tabletop makes it durable and easy to clean. Suitable for any indoor and outdoor environment.

COLORI BASE / BASIC COLOURS

Art. 6295 | FURA TABLE

- C2
- L4
- M9
- N2
- 87

PIANO / TOP

HPL - Rotondo / Round

Ø 60 - Art. **A4463**



Ø 60 - Art. **A4464**



HPL - Quadrato / Square

60x60 - Art. **A4468**



60x60 - Art. **A4469**



HPL - Rettangolare / Rectangular

180x60 - Art. **A4470**



180x60 - Art. **A4471**

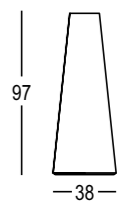

STRUCTURE

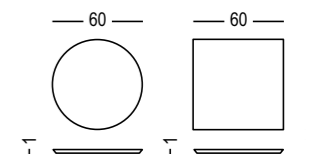

TOP



FUZZY STOOL

DESIGN
EDDY ANTONELLO
2008





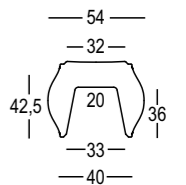

Sgabello/tavolino dalle forme morbide, versatile ed adattabile a differenti contesti d'uso. Abbinato al vaso "Fuzzy Pot" (vedi pag. 108 del catalogo) permette di creare delle composizioni totemiche attraverso innumerevoli soluzioni compositive e cromatiche, e capovolto diventa a sua volta un generoso contenitore per piante di media grandezza o oggetti di uso quotidiano.

Stool/coffee table with soft shapes, versatile and adaptable to different contexts of use. Coupled with the vessel "Fuzzy Pot" (see pag. 108 catalogue) allows you to create totemic compositions through numerous compositional solutions and colors, and flipped in turn becomes a generous container plants of medium size or everyday objects.



**COLORI BASE /
BASIC COLOURS**

Art. 6236 | FUZZY STOOL

- B2 
- C2 
- C9 
- 69 
- 87 

**LACCATI /
LACQUERED**

Art. 6536 | FUZZY STOOL

- D3 
- D7 
- 07 

**METALLIZZATI /
METALLIZED**

Art. 6836 | FUZZY STOOL

- E8 

GOEN + ENTA

FAMILY

DESIGN
SETSU & SHINOBU ITO



GOEN

DESIGN
SETSU & SHINOBU ITO
2008



Poltroncina in polietilene che trae ispirazione dal concetto orientale del "rapporto rotondo" espresso in termini formali per "favorire l'aggregazione" in un contesto di spazio relax. Ideale sia per l'outdoor che l'indoor, è disponibile in svariate finiture e colori.

Polyethylene armchair inspired by the Eastern concept of "relationship round" expressed in formal terms to "improve the grouping" in a context of space to relax. Ideal for the outdoors and the indoors, is available in several finishing and colors.

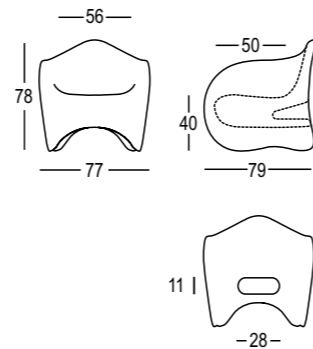

COLORI BASE / BASIC COLOURS	LACCATI / LACQUERED	METALLIZZATI / METALLIZED
Art. 6239 GOEN	Art. 6539 GOEN	Art. 6839 GOEN
C2	D7	E8
L4	03	
74	07	
86		
87		

ENTA

DESIGN
SETSU & SHINOBU ITO
2008



Coffee table realizzato in polietilene, leggero e facile da spostare. Disponibile in svariati colori.

Coffee table made of polyethylene, light and easy to move. Available in many colors.

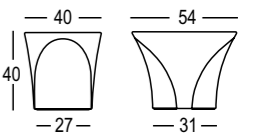

COLORI BASE / BASIC COLOURS	LACCATI / LACQUERED	METALLIZZATI / METALLIZED
Art. 6241 ENTA	Art. 6541 ENTA	Art. 6841 ENTA
C2	D7	E8
L4	03	
74	07	
86		
87		

GUMBALL FAMILY

DESIGN
ALBERTO BROGLIATO





GUMBALL ARMCHAIR

DESIGN
ALBERTO BROGLIATO
2009



Versione **light** /
Light version



Poltrona dalla forma ergonomica ed avvolgente, particolarmente adatta a contesti ricreativi. Disponibile in diverse varianti: in materiale laccato o in versione luminosa. Disponibile anche in edizione speciale, riempita di mille palline colorate che traspaiono dalla superficie traslucida e morbida.

Ergonomically shaped and enveloping armchair, especially suitable for recreational settings. Available in several variants may be produced in lacquered material or in version with light. The special edition is filled with thousands of colored balls that come through the translucent and soft surface available.

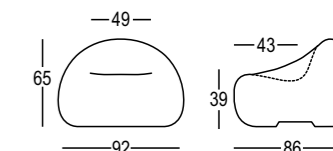

COLORI BASE / BASIC COLOURS

Art. 6246 | GUMBALL ARMCHAIR

Rigido / Hard

C2

G9

M9

N2

N4

87

LACCATI / LACQUERED

Art. 6546 | GUMBALL ARMCHAIR

Rigido / Hard

03

44

FINITURA SPECIALE / SPECIAL FINISHING

Art. 6243 | GUMBALL ARMCHAIR

Morbido con palline / Soft with little balls

98

COLORI SPECIALI / SPECIAL COLORS

Art. 6246 | GUMBALL ARMCHAIR

Rigido / Hard

INDUSTRIAL BLACK

P1

P2

P3

P4

P5

P6

FUNNY WHITE

N6

L7

N7

N8

N9

P0

URBAN FOREST

P8

P7

GUMBALL SOFA

DESIGN
ALBERTO BROGLIATO
2011



Divanetto 2 posti, dall'estetica morbida ed avvolgente, che bene si integra alla famiglia di complementi d'arredo corredata da poltrona, tavolino/contenitore e lettino prendisole. Sofa completa la famiglia di complementi d'arredo "Gumball".

Two-Seat Sofa, with soft and embracing aesthetics, well integrated with the family of furniture, which includes an armchair, table/container and sunlounge. Sofa completes the family of "Gumball" furnishing accessories.

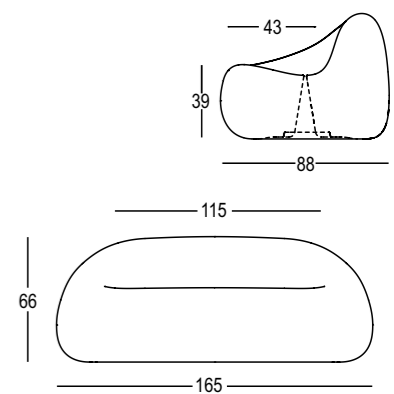

**COLORI BASE /
BASIC COLOURS**

Art. 6263 | GUMBALL SOFA

Rigido / Hard

C2

G9

M9

N2

N4

87

**LACCATI /
LACQUERED**

Art. 6563 | GUMBALL SOFA

Rigido / Hard

03

**COLORI SPECIALI /
SPECIAL COLORS**

Art. 6263 | GUMBALL SOFA

Rigido / Hard

INDUSTRIAL BLACK

P1

P2

P3

P4

P5

P6

FUNNY WHITE

N6

L7

N7

N8

N9

P0

URBAN FOREST

P8

P7



GUMBALL SUNLOUNGE

DESIGN
ALBERTO BROGLIATO
2011



Lettino prendisole da utilizzare in giardino o in zone relax, quali piscine, spa, resort, terme. L'inclinazione dello schienale consente una postura corretta e comoda. Disponibile un cuscino in ecopelle o tessuto tecnico.
PER MAGGIORI INFORMAZIONI SUI CUSCINI: vedi sezione tecnica pag. 270

This is a sunlounges to use in the garden or in an area dedicated to relaxation, such as a swimming pool, spa, resort or hot springs. The inclination of the back permits correct and comfortable posture. Sky or technical fabric cushion available.

FOR FURTHER INFORMATION ON THE CUSHIONS: see technical data section. 270

COLORI BASE / BASIC COLOURS

Art. 6262 | GUMBALL SUNLOUNGE
Rigido / Hard

C2

G9

M9

N2

N4

87

LACCATI / LACQUERED

Art. 6562 | GUMBALL SUNLOUNGE
Rigido / Hard

03

CUSCINO / CUSHION

Art. 30059

Ecopelle / Sky

Art. 30060

Tessuto tecnico / Technical fabric

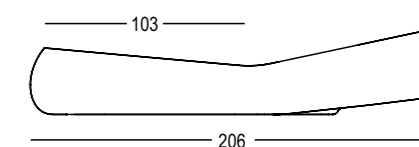
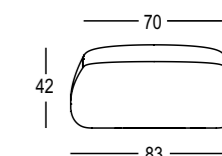

STRUCTURE

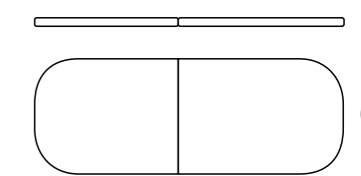

CUSHION



T BALL

DESIGN
ALBERTO BROGLIATO
2010



COLORI SPECIALI / SPECIAL COLORS

Art. 6248 | T BALL

Rigido / Hard

INDUSTRIAL BLACK

P1

P2

P3

P4

P5

P6

FUNNY WHITE

N6

L7

N7

N8

N9

P0

URBAN FOREST

P8

P7

PIANO / TOP COLORI BASE / BASIC COLOURS

Ø 63 - Art. A4261 | T BALL

PE - Polietilene / Polyethylene

C2

* Solo INDOOR / Only INDOOR

A2 M9

B3 11

C1 43

L4 74

COLORI BASE / BASIC COLOURS

Art. 6248 | T BALL

Rigido / Hard

C2

G9

M9

N2

N4

87

LACCATI / LACQUERED

Art. 6548 | T BALL

Rigido / Hard

03

44

PIANO / TOP COLORI BASE / BASIC COLOURS

Ø 63 - Art. A4261

PE - Polietilene / Polyethylene

C2

* Solo INDOOR / Only INDOOR

G9

M9

N2

N4

87

PIANO / TOP Legno / Wood*

Ø 63 - Art. A4263

Legno / Wood*

*Destinato all'utilizzo in ambiente esterno coperto. Non esporre alle intemperie.

*Intended for use in covered outdoor environments. Do not expose to the elements.

Tavolino / Contenitore
Attraverso l'introduzione di un piano di chiusura il vaso "T Ball" (vedi pag. 145 del catalogo) assume svariate funzioni traducendosi in nuove possibilità di sistemi d'uso. Utilizzato come tavolino o contenitore, risulta particolarmente adatto all'abbinamento con la poltrona "Gumball" (vedi pag. 57 del catalogo).

Table / Container
Through the introduction of a closure plan for the "T Ball" vase (see pag. 145 catalogue), it takes a variety of functions resulting in new opportunities for systems usage. Used as a coffee table or container, it's particularly suitable when matched with the armchair "Gumball" (see pag. 57 catalogue).

* Solo per INDOOR. Piano in polietilene + schiuma poliuretanic. Si consiglia l'uso indoor. In ambiente outdoor non esporre direttamente alla luce solare.

* Only INDOOR. Polyethylene top + polyurethane foam. We recommend indoor use. In the outdoor environment avoid directly solar light exposure.

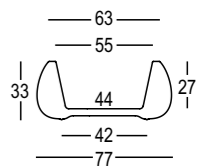

STRUCTURE

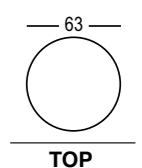

TOP

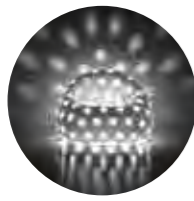

Versione **light** /
Light version

AIRBALL ARMCHAIR

DESIGN
ALBERTO BROGLIATO
2013



AIRBALL SOFA

DESIGN
ALBERTO BROGLIATO
2013

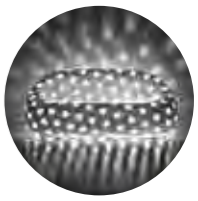

Versione **light** /
Light version



Poltroncina e divano derivati dalla famiglia "Gumball", di grande impatto scenico e adatti ad ambienti in cui necessitano soluzioni di forte personalità. La superficie forata "svuota" gli oggetti e conferisce una leggerezza inedita per questa tipologia di arredi.

The armchair and sofa deriving from the "Gumball" family has great impact and are suitable for rooms that require solutions with great character. The openings on the surface give unrivalled lightness for this kind of furniture.

COLORI BASE / BASIC COLOURS

Art. 6284 | AIRBALL ARMCHAIR

Art. 6283 | AIRBALL SOFA

C2

GUMBALL SOFA JUNIOR

DESIGN
ALBERTO BROGLIATO
2015



Divanetto a tre posti, abbinato alla poltrona "Gumball Junior" per ricreare degli angoli gioco, sicuri, ergonomici e versatili.

A three-seater sofa paired with the "Gumball Junior" Armchair to create safe, ergonomic, and versatile play areas.

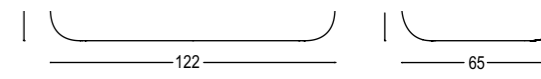

**COLORI BASE /
BASIC COLOURS**

Art. 6302 | GUMBALL SOFA JUNIOR
Rigido / Hard

- A2
- B3
- C1
- C2
- 11
- 43
- 74

**FINITURA SPECIALE /
SPECIAL FINISHING**

Art. 6303 | GUMBALL SOFA JUNIOR
Morbido con palline / Soft with little balls

98

**COLORI SPECIALI /
SPECIAL COLORS**

Art. 6302 | GUMBALL SOFA JUNIOR
Rigido / Hard

- | | |
|------------------|-------------|
| INDUSTRIAL BLACK | FUNNY WHITE |
| P1 | N6 |
| P2 | L7 |
| P3 | N7 |
| P4 | N8 |
| P5 | N9 |
| P6 | P0 |



PLUST VAN MINI PLUST VAN

DESIGN
MICHELE MENESCARDI
2016



Porta giocattoli, contenitore di sogni e simbolo di avventura. Il "Plust Van" condurrà i più piccoli e i loro giocattoli in bellissimi viaggi immaginari, gli adulti torneranno a sognare le avventure on the road. Un contenitore resistente, dalle forme morbide prive di spigoli. Adatto a tutti gli ambienti ed età, arreda con simpatia gli spazi living destinati ai bambini. Disponibile anche in versione Mini, da usare come portaoggetti o piccolo vaso.

Toy container, dream-box and a symbol of adventure. "The Plust Van" will take tiny tots and their toys on enchanting imaginary journeys, while adults will dream again of on-the-road adventures. A sturdy box with soft lines and no sharp edges. Great for all environments and ages, it lightens up kids' living spaces. Also available in Mini version for storage or to use as a small plant pot.

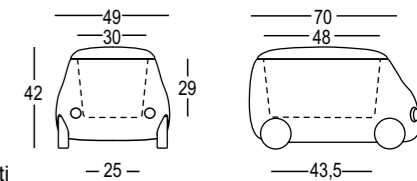

PLUST VAN

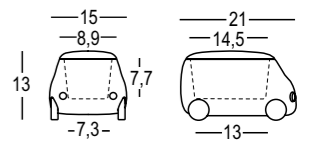

MINI PLUST VAN

COLORI BASE / BASIC COLOURS

Art. 6341 | PLUST VAN

Art. 6352 | MINI PLUST VAN

Struttura / Structure

A2

A6

C1

N4

11

74

86

Tetto / Top

C2

Ruote in Legno / Wood Wheels

Art. 6354 | PLUST VAN

Struttura / Structure

A2

A6

C1

N4

11

74

86

Tetto / Top

C2

Ruote in plastica / Plastic Wheels

C2

JETLAG FAMILY

DESIGN
CÉDRIC RAGOT



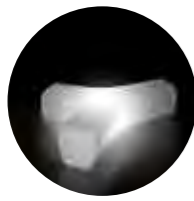

Versione light /
Light version

JETLAG

DESIGN
CÉDRIC RAGOT
2014



Panca modulare disegnata per grandi spazi indoor o outdoor, solida e resistente agli agenti atmosferici. Caratterizzata da scanalature che, oltre a creare una texturizzazione elegante, danno continuità quando più moduli vengono accostati assieme. Più elementi accostati possono ricreare comodi divani o composizioni articolate e dinamiche.

A sturdy, weather-resistant modular bench designed for large indoor and outdoor spaces. The grooves it features create an elegant texture and give continuity to the form, concealing the joints when multiple modules are put together. You can combine several units to create comfortable sofas or dynamic compositions.

**COLORI BASE /
BASIC COLOURS**

Art. 6291 | JETLAG

- C2
- N4
- 86
- 87

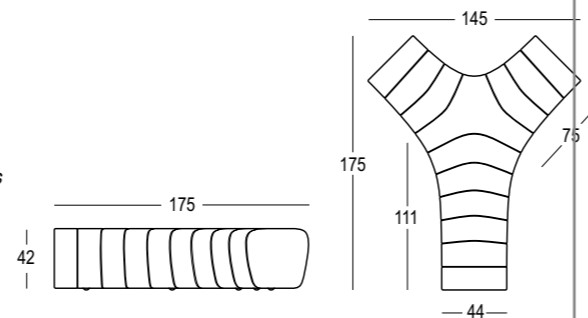

JETLAG CHAIR

DESIGN
CÉDRIC RAGOT
2014



Versione light /
Light version



Seduta modulare e spaziosa abbinata alla panca "Jetlag". Più elementi seduta accostati possono ricreare lunghi divani, mentre inseriti tra i moduli panca rendono articolata e dinamica la composizione.

A roomy modular chair matched with the "Jetlag" bench. You can combine several chairs to create long sofas or insert a bench between the modules to create dynamic compositions.

**COLORI BASE /
BASIC COLOURS**

Art. 6293 | JETLAG CHAIR

- C2
- N4
- 86
- 87

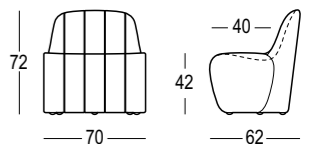

OHLA FAMILY

DESIGN
ALBERTO BROGLIATO



VANILLA
HOTEL

33 WEST

VANILLA HOTEL
MIAMI
★★★★



Versione light /
Light version

OHLA ARMCHAIR

DESIGN
ALBERTO BROGLIATO
2008



Poltroncina in polietilene dalle linee dinamiche e contemporanee. Arreda con personalità spazi sia interni che esterni. Abbinabile a "Fuzzy Stool" oppure a "T Ball", utilizzandoli come tavolino (vedi pag. 48, 62 del catalogo).

Polyethylene armchair with dynamic and contemporary lines. Both indoor and outdoor rooms are decorated with personality. Matching to "Fuzzy Stool" or "T Ball", used as a coffee table (see pag. 48, 62 catalogue).

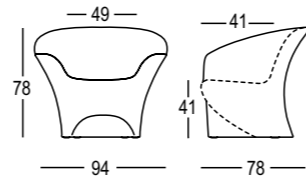

COLORI BASE / BASIC COLOURS	LACCATI / LACQUERED
Art. 6238 OHLA ARMCHAIR	Art. 6538 OHLA ARMCHAIR
C2	D7
L4	03
M9	07
N2	
N4	
69	
87	

OHLA SOFA

DESIGN
ALBERTO BROGLIATO
2015



Versione light /
Light version



Sofa a 3 posti abbinato alla poltrona "Ohla" per arredare ambienti e spazi relax con una linea fortemente caratterizzante dall'ergonomia confortevole.

A 3-seater sofa paired with the "Ohla armchair" to furnish relaxation spaces with a comfortable and ergonomic design.

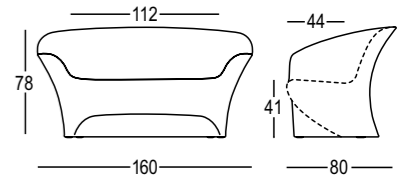

COLORI BASE / BASIC COLOURS	LACCATI / LACQUERED
Art. 6304 OHLA SOFA	Art. 6575 OHLA SOFA
C2	D7
L4	03
M9	07
N2	
N4	
69	
87	

PLANET FAMILY

DESIGN
CÉDRIC BAGOT



PLANET CHAIR

DESIGN
CÉDRIC RAGOT
2015

PLANET TABLE

DESIGN
CÉDRIC RAGOT
2015



Sedia molto confortevole dalle linee pulite ma di forte personalità. Le gambe in legno naturale o scuro, abbinata alla scocca in PE stampato in rotomoulding, conferiscono eleganza e allo stesso tempo modernità, rendendo questo prodotto stilisticamente versatile per diverse tipologie di ambienti. Adatta all'uso sia indoor che outdoor.

A very comfortable chair with a clean-cut design full of character. Its natural or dark wooden legs and elegant rotomoulded PE body make this an elegant, modern and versatile product that fits perfectly into any setting. Suitable for both indoor and outdoor use.

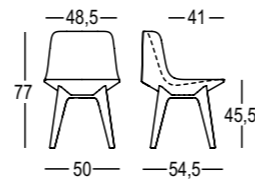

COLORI BASE / BASIC COLOURS

Art. 6322 | PLANET CHAIR

Struttura / Structure

C2

M9

N2

N4

70

86

87

Gambe in Legno / Wood Legs*

*Destinato all'utilizzo in ambiente esterno coperto. Non esporre alle intemperie.

*Intended for use in covered outdoor environments. Do not expose to the elements.

COLORI BASE / BASIC COLOURS

Art. 6314 | PLANET CHAIR

Struttura / Structure

C2

M9

N2

N4

70

86

87

Gambe in Legno / Wood Legs*

*Destinato all'utilizzo in ambiente esterno coperto. Non esporre alle intemperie.

*Intended for use in covered outdoor environments. Do not expose to the elements.

COLORI BASE / BASIC COLOURS

Art. 6318 | SET PLANET TABLE LEGS

Struttura / Structure

C2

M9

N2

N4

70

86

87

PIANO / TOP

HPL - Quadrato / Square

100x100 - Art. **A4500**

100x100 - Art. **A4501**

100x100 - Art. **A4501**

100x100 - Art. **A4504**

100x100 - Art. **A4505**

100x100 - Art. **A4505**

100x100 - Art. **A4505**

100x100 - Art. **A4505**

PIANO / TOP

Legno / Wood*

200x90 - Art. **A4506**

200x90 - Art. **A4507**

200x90 - Art. **A4507**

*Destinato all'utilizzo in ambiente esterno coperto. Non esporre alle intemperie.

*Intended for use in covered outdoor environments. Do not expose to the elements.

*Destinato all'utilizzo in ambiente esterno coperto. Non esporre alle intemperie.

*Intended for use in covered outdoor environments. Do not expose to the elements.

*Destinato all'utilizzo in ambiente esterno coperto. Non esporre alle intemperie.

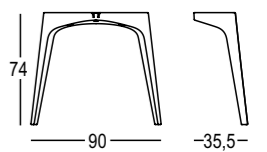

STRUCTURE

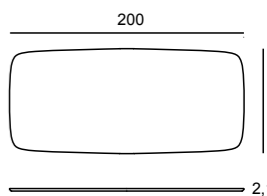
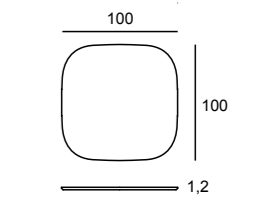

TOP



SAT
DESIGN
MARCO ZITO
2012



Selezione ADI Design Index 2013
ADI Design Index 2013 selection

Seduta che grazie al piano d'appoggio girevole in legno o HPL, risulta ideale per soste brevi in spazi pubblici di grande passaggio come bar, aree relax e spazi ad uso commerciale quali sale studio, aree meeting, biblioteche.

This chair with a wood or HPL tablet is ideal for short stops in high-traffic public areas, such as bars, relaxation areas, study rooms, meeting rooms, and libraries.

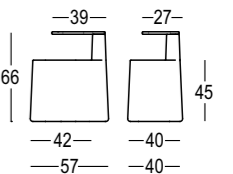

**COLORI BASE /
BASIC COLOURS**

Art. 6271 | SAT

Struttura / Structure

C2

C7

G9

PIANO / TOP

Legno / Wood*

*Destinato all'utilizzo in ambiente esterno coperto. Non esporre alle intemperie.

**Intended for use in covered outdoor environments. Do not expose to the elements.*

**COLORI BASE /
BASIC COLOURS**

Art. 6297 | SAT

Struttura / Structure

C2

C7

G9

PIANO / TOP

HPL - Piano bianco / White top

**COLORI BASE /
BASIC COLOURS**

Art. 6298 | SAT

Struttura / Structure

C2

C7

G9

PIANO / TOP

HPL - Piano nero / Black top



SIMPLE FAMILY

DESIGN
JOVELLUTO (JVLT) +
EDDY ANTONELLO



SIMPLE CHAIR

DESIGN
JOEVELLUTO (JVL) +
EDDY ANTONELLO
2010



Seduta impilabile, in PE polietilene stampato in rotomoulding, solida e ideale per l'esterno in quanto dotata di foro di scolo dell'acqua, da utilizzare anche come pratico punto di presa per lo spostamento. "Simple Chair" è una seduta archetipo dalla semplicità apparente, che ben si inserisce all'interno di spazi pubblici o domestici, indoor e outdoor.

A sturdy, stackable chair made of rotomoulded polyethylene and suitable for outdoor use as it has a drain hole, which can also be used as a grasp point to move it around easily. "Simple Chair" in an archetype chair that fits perfectly into public and domestic, indoor and outdoor spaces.

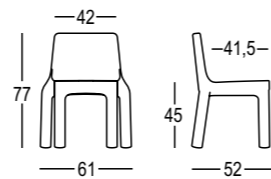

COLORI BASE / BASIC COLOURS

Art. 6257 | SIMPLE CHAIR

- C1
- C2
- G9
- 86
- 87

SIMPLE TABLE

DESIGN
JOEVELLUTO (JVL) +
EDDY ANTONELLO
2010



Tavolo adatto all'esterno in PE polietilene stampato in rotomoulding e dotato di canali di scolo in tutto il piano d'appoggio. Le gambe smontabili e disponibili in diversi colori, offrono la possibilità di creare molteplici soluzioni cromatiche per differenti contestualizzazioni d'arredo.

A rotomoulded polyethylene table suitable for outdoor use and equipped with drain holes over the entire top. The removal legs, available in various colours, allow you to create multiple solutions for any setting.

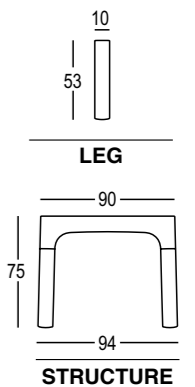

COLORI BASE / BASIC COLOURS

Art. 6255 | SIMPLE TABLE

- C2
- G9
- 87

COLORI BASE / BASIC COLOURS

Art. 6258 | GAMBA / LEG

- C1
- C2
- G9
- 86
- 87

TALEA FAMILY

DESIGN
MARCO ZITO



TALEA CHAIR

DESIGN
MARCO ZITO
2011



Oggetto versatile con piano di seduta in tessuto o legno che, come suggerisce il nome, con un semplice incastro centrale può trasformarsi in panca per soste brevi in spazi pubblici, sale attese e aree di passaggio.

Versatile object with a fabric or wooden seating which, as the name suggests, with a simple central notch, it can generate a bench suitable for public spaces and waiting rooms.

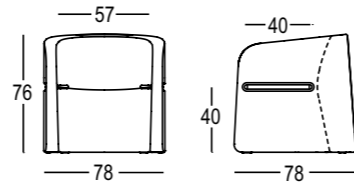

COLORI BASE / BASIC COLOURS

Art. 6264 | TALEA CHAIR

Struttura / Structure

C2

Tessuto / Fabric



Art. 6336 | TALEA CHAIR

Struttura / Structure

G9

Tessuto / Fabric



LACCATI / LACQUERED

Art. 6564 | TALEA CHAIR

Struttura / Structure

03

07

Tessuto / Fabric



COLORI BASE / BASIC COLOURS

Art. 6265 | TALEA CHAIR

Struttura / Structure

C2

G9

Legno / Wood*

*Destinato all'utilizzo in ambiente esterno coperto. Non esporre alle intemperie.

*Intended for use in covered outdoor environments. Do not expose to the elements.

LACCATI / LACQUERED

Art. 6565 | TALEA CHAIR

Struttura / Structure

03

07

Legno / Wood*

*Destinato all'utilizzo in ambiente esterno coperto. Non esporre alle intemperie.

*Intended for use in covered outdoor environments. Do not expose to the elements.

TALEA BENCH

DESIGN
MARCO ZITO
2011



Panca composta da due poltroncine "Talea" e un piano seduta in legno di betulla. Questa composizione genera un utile piano d'appoggio tra le due sedute.

Bench made of two "Talea Chairs" and a birch plywood seating. This composition generate a useful top between the two chairs.

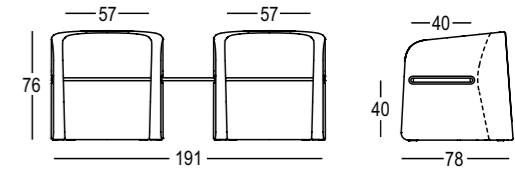

COLORI BASE / BASIC COLOURS

Art. 6266 | TALEA BENCH

Struttura / Structure

C2

G9

Legno / Wood*

*Destinato all'utilizzo in ambiente esterno coperto. Non esporre alle intemperie.

*Intended for use in covered outdoor environments. Do not expose to the elements.

LACCATI / LACQUERED

Art. 6566 | TALEA BENCH

Struttura / Structure

03

07

Legno / Wood*

*Destinato all'utilizzo in ambiente esterno coperto. Non esporre alle intemperie.

*Intended for use in covered outdoor environments. Do not expose to the elements.

POTS

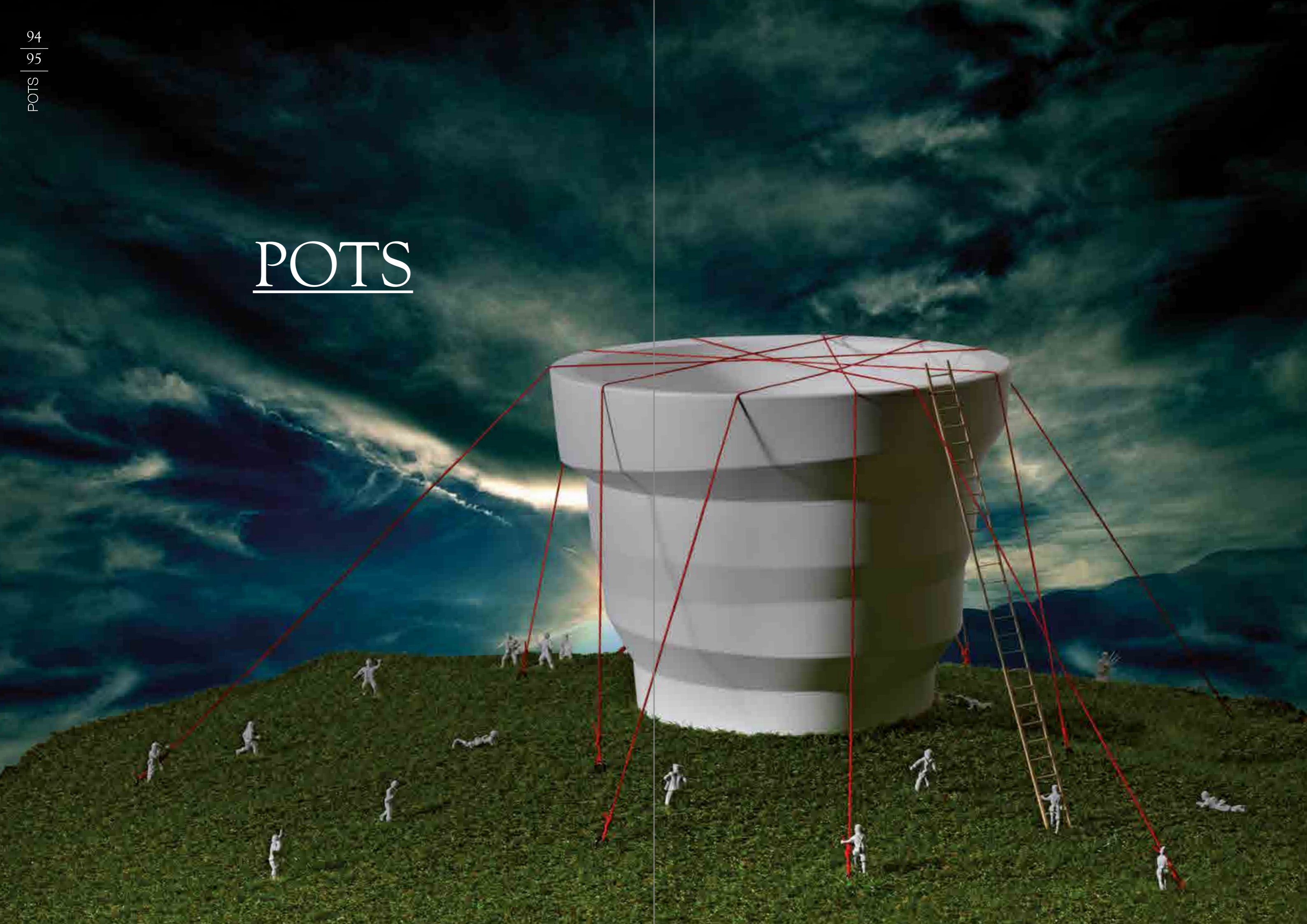



BOYO

DESIGN
GENTLE GIANTS
2012



Vaso totemico dalle grandi forme che richiama la figura stilizzata di un elemento naturale come un fiore. Abbinato al vaso "Harbo" (vedi pag. 114 del catalogo) può creare delle ambientazioni di grande impatto emozionale, rievocando un prato di grandi fiori fuori scala. Necessita di base di stabilizzazione o fissaggio - vedi sezione tecnica pag. 276.

Capacious totem vase reminiscent of the stylised figure of a natural element, such as a flower. Combined with the "Harbo" (see pag. 114 catalogue) vase, it may be placed to create great emotional impact in the environment, evoking a meadow of oversized flowers. Needs a stability base or a stability and ground fixing base - see technical data pag. 276.

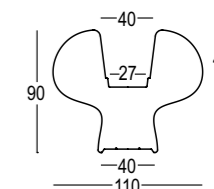

**COLORI BASE /
BASIC COLOURS**

Art. 6270 | BOYO

A2

C2

86

**LACCATI /
LACQUERED**

Art. 6570 | BOYO

D7

03

86



BUBA

DESIGN
E3P DESIGN DEPT.
2007



Versione **light** /
Light version



Vaso contraddistinto da una presenza imponente ma slanciata che lo rende particolarmente adatto al posizionamento ai lati di un ingresso o di un percorso, sia in contesti minimal che fortemente caratterizzati. Ideale per piante o decorazioni vegetali di media dimensione a sviluppo verticale, sia in ambienti outdoor che indoor. Disponibile base di stabilizzazione o stabilizzazione e fissaggio - vedi sezione tecnica pag. 276.

Vase marked by a slender yet imposing presence that makes it particularly suitable placed on either side of an entrance or path, either as minimal concept or as strongly characterized. Ideal for plants or green medium-sized vertical development decorations, both in indoor and outdoor environments.
Available a stability base or a stability and ground fixing base - see technical data pag. 276.

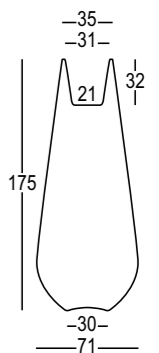

**COLORI BASE /
BASIC COLOURS**

Art. 6202 | BUBA

- A5
- C2
- 86
- 87

**LACCATI /
LACQUERED**

Art. 6502 | BUBA

- D7
- 03
- 07
- 86

**METALLIZZATI /
METALLIZED**

Art. 6802 | BUBA

- C8



CACTUS

DESIGN
GIULIO IACCHETTI
2007



Due piccoli vasi porta piante ricavati dalla forma stilizzata di un cactus oversize dal basamento stabile che rimanda agli anni '60. Ideale per caratterizzare con originalità ambienti outdoor e indoor.

Two small plant vase derived from the stylized shape of an oversize cactus from a stable base which refers to the '60s. Ideal to characterize indoor and outdoor environments with originality.

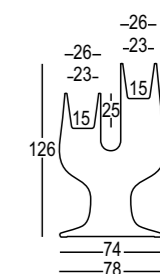

COLORI BASE / BASIC COLOURS

Art. 6221 | CACTUS

C2

69

74

86

LACCATI / LACQUERED

Art. 6521 | CACTUS

07

86

METALLIZZATI / METALLIZED

Art. 6821 | CACTUS

C8



CUBALIBRE

DESIGN
GIULIO IACCHETTI
2007



Oggetto che dal tumbler trae diretta ispirazione.
Le sue dimensioni lo rendono particolarmente adatto per piante o decorazioni vegetali di media/grande dimensione, o per diventare all'occorrenza il punto di riferimento di una festa, un enorme bicchiere riempito di ghiaccio dove poter rinfrescare le bottiglie.

An object that takes its cue from a tumbler. Its size makes it particularly suitable for plants or medium/large plant decorations, or to become the reference point of an event, a huge glass filled with ice where you can cool beverage bottles.

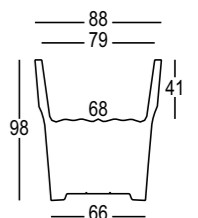

**COLORI BASE /
BASIC COLOURS**

Art. 6223 | CUBALIBRE

A5

C2

34

**LACCATI /
LACQUERED**

Art. 6523 | CUBALIBRE

03

07

44

**METALLIZZATI /
METALLIZED**

Art. 6823 | CUBALIBRE

C8



DIAMOND

DESIGN
JOEVELLUTO (JVL)
2007



Vaso dalle linee pulite ed essenziali che rievocano il taglio delle pietre preziose. Disponibile in due misure, risulta particolarmente adatto a spazi ed architetture dal gusto contemporaneo. Ideale per piante o decorazioni vegetali di media/piccola dimensione.

Vase that by clean lines, recalls gemstones. Available in two sizes, is especially suited to architectural spaces and contemporary taste. Ideal for plants or small/medium size plant decoration.

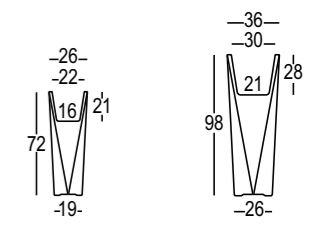

DIAMOND 72

DIAMOND 98

**COLORI BASE /
BASIC COLOURS**

Art. 6213 | DIAMOND 72
Art. 6214 | DIAMOND 98

- C2
- 69
- 84
- 87

**LACCATI /
LACQUERED**

Art. 6513 | DIAMOND 72
Art. 6514 | DIAMOND 98

- D8
- 03
- 07

**METALLIZZATI /
METALLIZED**

Art. 6813 | DIAMOND 72
Art. 6814 | DIAMOND 98

- C8



DROP

DESIGN
EMMANUEL BABLED
2010



Versione **light** /
Light version



Adatto ad uso interno ed esterno, il vaso "Drop" è disegnato da una linea che vede nella versatilità la caratteristica fondamentale. Suggestivo l'abbinamento con piante grasse o rami secchi decorativi per accentuare il contrasto con la semplicità della forma. Ideale per piante o decorazioni vegetali di media dimensione.

Suitable for indoor and outdoor use, the vase "Drop" is a line drawn from the main feature seen in versatility. Suggestive pairing with cacti plants or decorative dried branches to accentuate the contrast with the simplicity of its form. Ideal for plants or average size plant decorations.

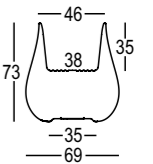

**COLORI BASE /
BASIC COLOURS**

Art. 6254 | DROP

C2

G9

74

86

87

**LACCATI /
LACQUERED**

Art. 6554 | DROP

D8

03

07



FUZZY POT

DESIGN
EDDY ANTONELLO
2008



Vaso dalle morbide forme che ben si adatta ad ambienti di dimensioni contenute.
Abbinato a "Fuzzy Stool" (vedi pag. 48 del catalogo) permette di creare delle composizioni totemiche realizzando innumerevoli soluzioni compositive e cromatiche.

Vase with soft shapes, well suited to limited size environments.
Combined with "Fuzzy Stool" (see pag. 48 catalogue) allows you to create totemic compositions creating numerous compositional solutions and colors.

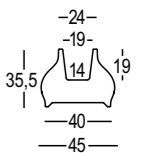

**COLORI BASE /
BASIC COLOURS**

Art. 6237 | FUZZY POT

- B2
- C2
- C9
- 69
- 87

**LACCATI /
LACQUERED**

Art. 6537 | FUZZY POT

- D3
- D7
- 07

**METALLIZZATI /
METALLIZED**

Art. 6837 | FUZZY POT

- E8



GIOTTO, MAX, RENÈ

DESIGN
MIRIAM MIRRI
2007



Piccoli vasi/totem da terra che portano il nome di 3 fantastici personaggi, stilisticamente in armonia fra loro, ma capaci di vivere anche singolarmente. Disponibili in svariati colori sia per esterno che interno, possono essere anche delle divertenti sculture adatte ad arredare spazi con un approccio ludico e contemporaneo. Disponibile base di stabilizzazione o stabilizzazione e fissaggio - vedi sezione tecnica pag. 276.

Small ground pots/totems carrying the name of 3 imaginary characters, stylistically in harmony with each other, but also able to live individually. Available in many colors for both external and internal environments, can also be fun sculptures suitable for furnishing spaces with a playful and contemporary approach. Available a stability base or a stability and ground fixing base - see technical data pag. 276.

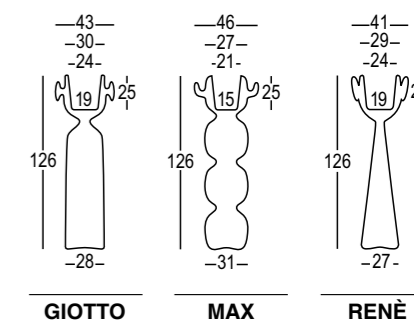

**COLORI BASE /
BASIC COLOURS**

Art. 6228 | GIOTTO
Art. 6229 | MAX
Art. 6230 | RENÈ

A9
C2
86
87

**LACCATI /
LACQUERED**

Art. 6528 | GIOTTO
Art. 6529 | MAX
Art. 6530 | RENÈ

03
07
86

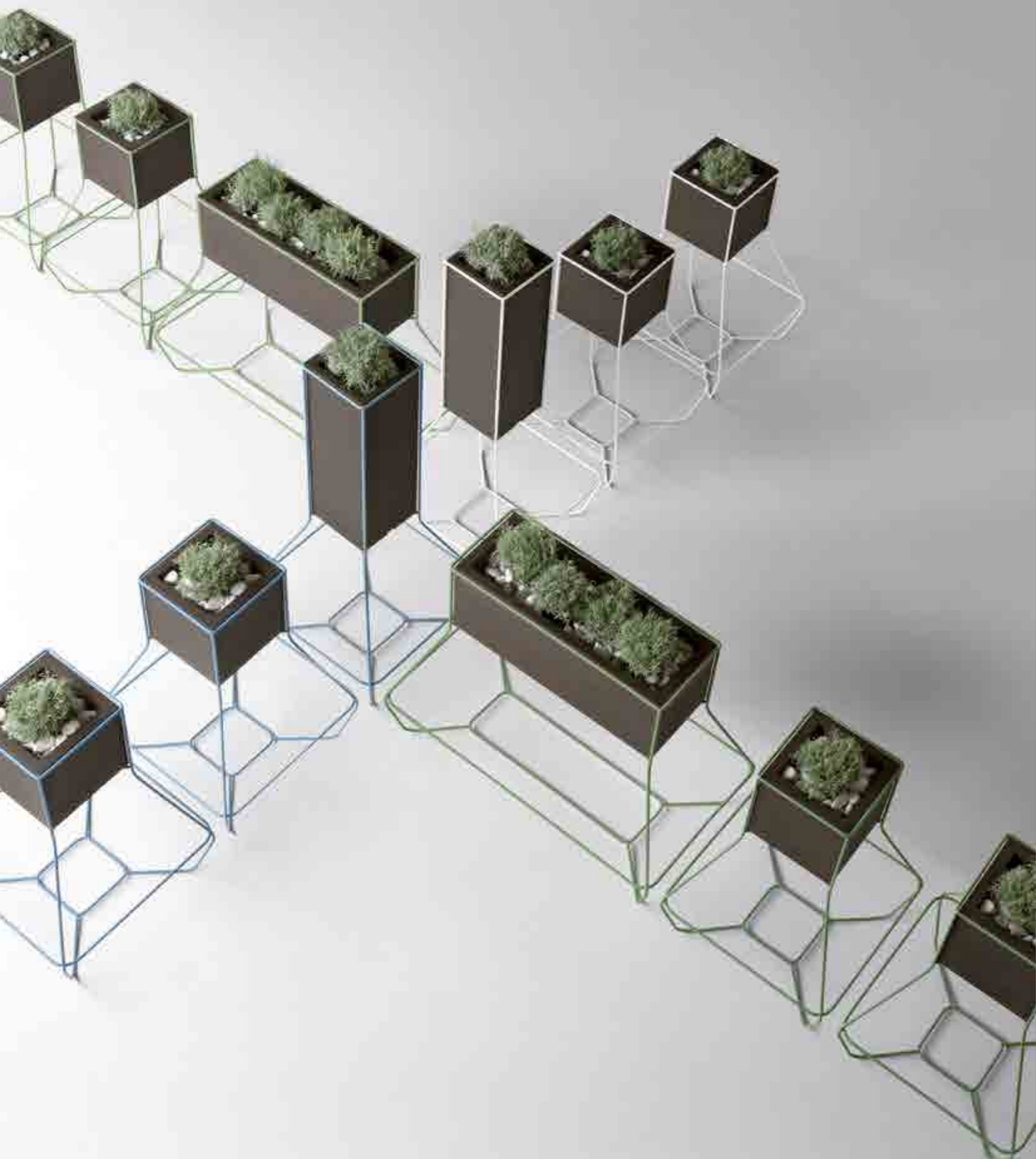

HALFUL

DESIGN
JOEVELLUTO (JVL)
2015

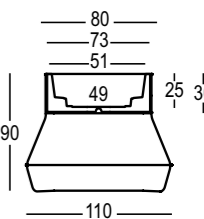
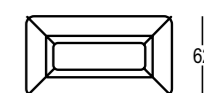
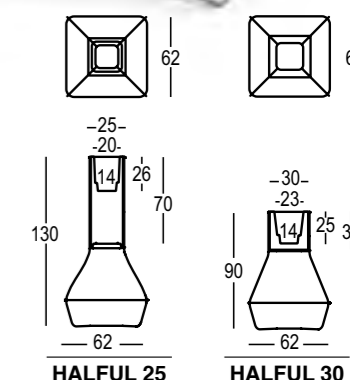

Set di vasi dalla presenza elegante e contemporanea. Le geometrie della struttura metallica si fondono con i volumi della vasca/contenitore, ottenendo delle preziose figure totemiche che arredano con discrezione. Il set di vasi Halful nasce con l'intento di ottenere un vaso in PE composto da una minima percentuale volumetrica di plastica e una percentuale di "vuoto" delineato dal wireframe metallico. Le vasche/contenitore sono composte da plastica "rigenerata", ottenuta cioè dal riciclo di scarti di produzione selezionati e ristampati (vedi sezione tecnica "Finiture"). I vasi sono disponibili con kit di riserva acqua su richiesta.

A set of elegant and contemporary vases. The shape of the metal structure blends with the volumes of the container, thereby creating precious totem-like items that decorate the room discreetly. The Halful vase collection stems from the idea to make a PE vase made with a minimum amount of recycled plastic and a "void" outlined by the metal wireframe. The container structure is made with regenerated plastic recycled from selected production scraps and remoulded (see "Finishings" on technical section). The vases are available with a water reservoir upon request.

COLORI BASE / BASIC COLOURS

Vaso / Vase

F1 

VERNICIATO / VARNISHED

Struttura metallo / Metal structure

- Art. 6324 | HALFUL 25
- Art. 6328 | HALFUL 30
- Art. 6332 | HALFUL 80



Struttura metallo / Metal structure

- Art. 6326 | HALFUL 25
- Art. 6330 | HALFUL 30
- Art. 6334 | HALFUL 80



VERNICIATO / VARNISHED

Struttura metallo / Metal structure

- Art. 6325 | HALFUL 25
- Art. 6329 | HALFUL 30
- Art. 6333 | HALFUL 80



SATINATO / SATIN

Struttura metallo / Metal structure

- Art. 6327 | HALFUL 25
- Art. 6331 | HALFUL 30
- Art. 6335 | HALFUL 80





HARBO

DESIGN
GENTLE GIANTS
2012



Versione **light** /
Light version



Vaso totemico dalle grandi forme sinuose che richiama la figura stilizzata di un tulipano. Abbinato al vaso "Boyo" (vedi pag. 96 del catalogo) può creare delle ambientazioni di grande impatto emozionale, rievocando un prato di grandi fiori fuori scala. Necessita di base di stabilizzazione o stabilizzazione e fissaggio - vedi sezione tecnica pag. 276.

Totem vase with ample, sinuous shapes reminiscent of the stylised figure of a tulip. Combined with the "Boyo" (see pag. 96 catalogue) vase, it may be placed to create great emotional impact in the environment, evoking a meadow of oversized flowers. Needs a stability base or a stability and ground fixing base - see technical data pag. 276.

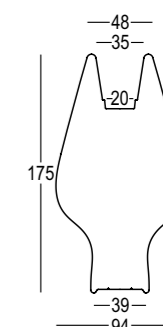

**COLORI BASE /
BASIC COLOURS**

Art. 6269 | HARBO

A2

C2

86

**LACCATI /
LACQUERED**

Art. 6569 | HARBO

D7

03

86

HUMPREY

DESIGN
JOEVELLUTO (JVL)
2007

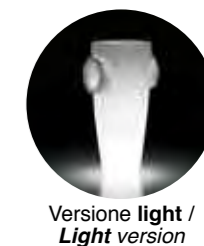

Vaso che si propone come una rivisitazione contemporanea dell'anfora classica. Grazie ai grandi "anelli" laterali, è possibile ottenere un inedito separè accostando più "Humprey" uno vicino all'altro. Ideale per piante o decorazioni vegetali di media dimensione. Disponibile base di stabilizzazione o stabilizzazione e fissaggio - vedi sezione tecnica pag. 276.

Vase proposed as a contemporary reinterpretation of a classic amphora. Thanks to the great side "rings", you can create rather unusual booths placing one "Humprey" next to the other. Ideal for plants or medium size plant decorations. Available a stability base or a stability and ground fixing base - see technical data pag. 276.

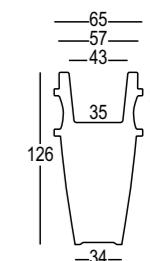

**COLORI BASE /
BASIC COLOURS**

Art. 6226 | HUMPREY

C2

69

86

87

**LACCATI /
LACQUERED**

Art. 6526 | HUMPREY

03

07

86

**METALLIZZATI /
METALLIZED**

Art. 6826 | HUMPREY

C8





MADAME

DESIGN
ALESSANDRO BUSANA
2007



Trittico di vasi dalle forme fluide che riecheggiano l'armonia sinuosa di un corpo femminile. Ideali per piante e decorazioni vegetali di piccola dimensione o a sviluppo verticale. I tre soggetti possono vivere anche singolarmente.

Triptych of vases with fluid forms that echo the sinuous harmony of a female body. Ideal for small size or vertical shaped plants. The three parties can also live individually.

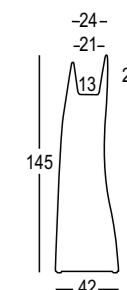
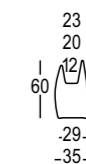

MADAME 60

MADAME 95

MADAME 145

COLORI BASE / BASIC COLOURS

Art. 6217 | MADAME 60

Art. 6218 | MADAME 95

Art. 6219 | MADAME 145

C2 87

LACCATI / LACQUERED

Art. 6517 | MADAME 60

Art. 6518 | MADAME 95

Art. 6519 | MADAME 145

D7 03 07

METALLIZZATI / METALLIZED

Art. 6817 | MADAME 60

Art. 6818 | MADAME 95

Art. 6819 | MADAME 145

C8



MOAI

DESIGN
LUCA NICHETTO
2007



Vaso slanciato dalla forma fluida che richiama le imponenti sculture dell'Isola di Pasqua. Una silhouette archetipa disponibile in 2 formati per vivere in coppia o singolarmente. Ideali per piante e decorazioni vegetali di piccola dimensione o a sviluppo verticale. Disponibile base di stabilizzazione o stabilizzazione e fissaggio - vedi sezione tecnica pag. 276.

Slender fluid-shaped vase reminiscent of the massive sculpture of Easter Island. An archetypal silhouette available in two sizes to live in pairs or individually. Ideal for small size or vertical shaped plants. Available a stability base or a stability and ground fixing base - see technical data pag. 276.

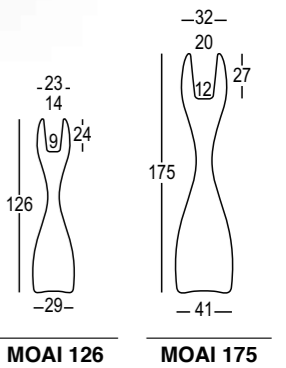

**COLORI BASE /
BASIC COLOURS**

Art. 6209 | MOAI 126
Art. 6210 | MOAI 175

C2

87

**LACCATI /
LACQUERED**

Art. 6509 | MOAI 126
Art. 6510 | MOAI 175

D3

07

86

**METALLIZZATI /
METALLIZED**

Art. 6809 | MOAI 126
Art. 6810 | MOAI 175

C8

E8

MOAI 126

MOAI 175



MORE

DESIGN
E3P DESIGN DEPT.
2009



Vaso di dimensioni medie che lo rendono adatto sia a spazi domestici che pubblici.
La texturizzazione delle superfici e le finiture disponibili rimandano idealmente alle increspature di un foglio d'alluminio, che mutano la forma a seconda dell'intensità luminosa dell'ambiente in cui viene inserito. Ideale per piante o decorazioni vegetali di media dimensione.

*Medium size jar suitable for both domestic and public spaces.
The surface texturing and finishing ideally refer to the ripples of foil, which changes shape depending on the light intensity of the environment in which it is placed. Ideal for plants or medium size plant decorations.*

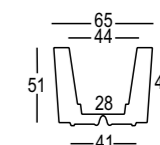

COLORI BASE / BASIC COLOURS

Art. 6244 | MORE

C2

87

FINITURA SPECIALE / SPECIAL FINISHING

Art. 6844 | MORE

C0



NICOLE

DESIGN
ILARIA MARELLI
2007



Versione light /
Light version



Vaso con doppio vano, disponibile in due misure. La forma semplice ed essenziale lo rende adattabile a qualsiasi contesto abitativo o spazio pubblico, scegliendo di posizionarlo in un verso, oppure capovolto. Disponibile base di stabilizzazione o stabilizzazione e fissaggio - vedi sezione tecnica pag. 276.

Double space vase, available in two sizes. The simple and essential shape makes it adaptable to any living environment or public space, with the chance place it in one direction or upside down. Available a stability base or a stability and ground fixing base - see technical data pag. 276.

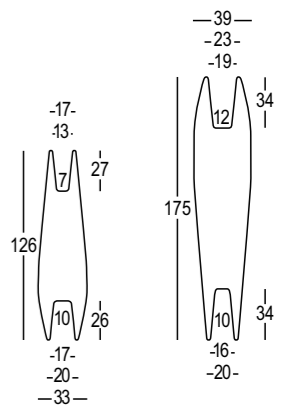

NICOLE 126 NICOLE 175

COLORI BASE / BASIC COLOURS

Art. 6207 | NICOLE 126
Art. 6208 | NICOLE 175

C2

69

87

LACCATI / LACQUERED

Art. 6507 | NICOLE 126
Art. 6508 | NICOLE 175

D7

03

07

METALLIZZATI / METALLIZED

Art. 6807 | NICOLE 126
Art. 6808 | NICOLE 175

C8



NINFEA

DESIGN
ALESSANDRO BUSANA
2007



Vaso galleggiante disponibile in due formati. Ideale per spazi esterni che presentano specchi naturali o artificiali. Oltre che come vaso per piante, può essere utilizzato anche come contenitore galleggiante in contesti outdoor come piscine o vasche termali.

Floating vase available in two formats. Ideal for outdoor areas that have natural or artificial mirrors. As well as a pot for plants, it can also be used as a floating container in contexts such as outdoor swimming pools or spas.

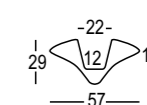

NINFEA 57

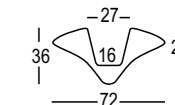

NINFEA 72

COLORI BASE / BASIC COLOURS

Art. 6211 | NINFEA 57

Art. 6212 | NINFEA 72

- A5
- B1
- C2
- 69
- 86

RÀ
DESIGN
VALERIO TONEL
2007



Vaso dalla forma conica svasata, caratterizzato nella sezione superiore da una forma ad ogiva. Versatile e adatto a spazi sia interni che esterni. Ideale per piante o decorazioni vegetali di media dimensione.
Vase-shaped conical flared upper section characterized by a cone shape. Versatile and suitable for both indoor and outdoor spaces. Ideal for plants or plant decorations of medium size.

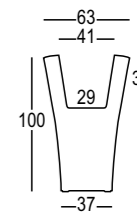

**COLORI BASE /
BASIC COLOURS**

Art. 6203 | RÀ

- A5
- C2
- 69
- 87

**LACCATI /
LACQUERED**

Art. 6503 | RÀ

- D7
- 03
- 07
- 86

**METALLIZZATI /
METALLIZED**

Art. 6803 | RÀ

- C8
- E8



REBELOT

DESIGN
MATTEO RAGNI
2007



Versione light /
Light version

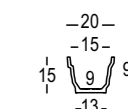

MINI REBELOT

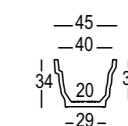

REBELOT 45

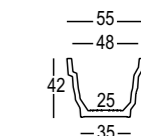

REBELOT 55

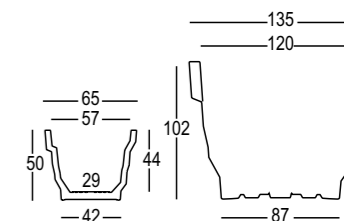

REBELOT 65

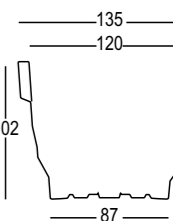

REBELOT

Vaso dallo stile irregolare. Nel dialetto milanese, "rebelot" significa "caos" ed è proprio l'apparente caotico cambio di piani che caratterizza la forma. La disponibilità in 5 formati diversi, lo rendono ideale per piante o decorazioni vegetali di diverse dimensioni. Nella versione maxi si rende particolarmente adatto ad hall di ambienti collettivi o spazi aperti.

Irregular style vase. In the Milanese dialect, "rebelot" means "chaos" and that is the apparent chaotic change of plans that characterizes the shape. The availability of 5 different formats, makes it ideal for plants or different size plant decorations. The maxi version is particularly suitable for halls of community environments or outdoors.

**COLORI BASE /
BASIC COLOURS**

Art. 6268 | MINI REBELOT

C2

74

86

**COLORI BASE /
BASIC COLOURS**

Art. 6231 | REBELOT 45

Art. 6232 | REBELOT 55

Art. 6233 | REBELOT 65

Art. 6224 | REBELOT

C2

86

87

**LACCATI /
LACQUERED**

Art. 6531 | REBELOT 45

Art. 6532 | REBELOT 55

Art. 6533 | REBELOT 65

Art. 6524 | REBELOT

D7

03

07

86

**METALLIZZATI /
METALLIZED**

Art. 6831 | REBELOT 45

Art. 6832 | REBELOT 55

Art. 6833 | REBELOT 65

Art. 6824 | REBELOT

C8



REVERSE

DESIGN
MATTEO RAGNI
2007



Vaso caratterizzato da un doppio vano: è possibile infatti utilizzare il vano più grande, oppure capovolgendolo, quello più piccolo a seconda del contesto e della tipologia di pianta che si desidera inserire.
Due o più "Reverse" accoppiati possono trasformarsi in utili elementi per separare gli spazi.

Double space vase: it is possible to use the larger slot, or inverted, the smaller one depending on the context and the type of plant you want to insert. Two or more "Reverse" coupled may become useful elements to separate spaces.

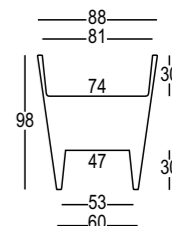

COLORI BASE / BASIC COLOURS

Art. 6227 | REVERSE

C2

69

84

87

LACCATI / LACQUERED

Art. 6527 | REVERSE

07

86



ROO

DESIGN
MONICA GRAFFEO
2008

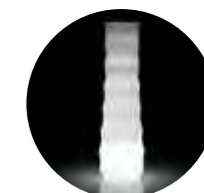

Versione **light** /
Light version



Il mondo vegetale delle piante grasse ispira la forma di questo vaso caratterizzato da un modulare cambio di superficie che gli permette di caratterizzare gli spazi in cui viene collocato con una forte personalità. Disponibile base di stabilizzazione o stabilizzazione e fissaggio - vedi sezione tecnica pag. 276.

The world of cacti plants inspired the shape of this vase featuring a modular surface exchange that can characterize the spaces in which it is placed with a strong personality. Available a stability base or a stability and ground fixing base - see technical data pag. 276.

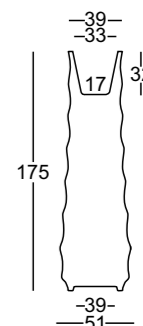

**COLORI BASE /
BASIC COLOURS**

Art. 6235 | ROO

- C2
- 69
- 86
- 87

**LACCATI /
LACQUERED**

Art. 6535 | ROO

- D3
- 07

**METALLIZZATI /
METALLIZED**

Art. 6835 | ROO

- E7



SAVING/SPACE/VASE

DESIGN
JOEVELLUTO (JVL)
2009



Versione **light** /
Light version



Vaso sottoposto ad un trattamento di "compressione" subito dopo essere estratto dallo stampo, quando per qualche minuto il materiale è ancora parzialmente malleabile. L'oggetto industriale originario assume una nuova connotazione assumendo un'estetica di volta in volta diversa. Un'azione artigianale che produce pezzi unici ma industriali. Disponibile base di stabilizzazione o stabilizzazione e fissaggio - vedi sezione tecnica pag. 276.

"Saving/Space/Vase" undergoes a process of "compression" immediately after being removed from its mould, when the material is still partially malleable for a few minutes. The original industrial object takes on a new connotation enriched by an aesthetic different from time to time. A craft action that produces unique but industrial pieces. Available a stability base or a stability and ground fixing base - see technical data pag. 276.

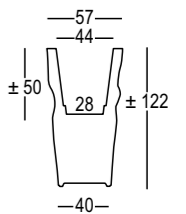

COLORI BASE / BASIC COLOURS

Art. 6247 | **SAVING/SPACE/VASE**

- A5
- C2
- 86
- 87



SEPIO

DESIGN
MATTEO RAGNI
2007



Vaso dall'aspetto "friendly" caratterizzato da tre gambe che stilisticamente rievocano la figura di un polipo. Il vano interno permette l'inserimento di piante di media/piccola misura o la possibilità di realizzare divertenti composizioni che ben si adattano alla forma ludica dell'oggetto.

This "friendly-looking" vase features three legs that stylistically recalls the figure of an octopus. The interior allows the inclusion of medium/small size plant, or the possibility of creating entertaining compositions that are well suited to the playful object.

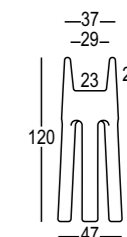

COLORI BASE / BASIC COLOURS

Art. 6220 | SEPIO

A5 

C2 

84 

86 

LACCATI / LACQUERED

Art. 6520 | SEPIO

D7 

07 

86 



SHOCK

DESIGN
ALBERTO BROGLIATO
2007



Vaso dall'estetica contemporanea contraddistinto da effetti ottici di torsione e movimento. Le sue dimensioni lo rendono versatile sia per spazi domestici che pubblici ed il vano risulta ideale per piante o decorazioni vegetali di media dimensione.

Vase with contemporary aesthetic characterized by optical effects of torque and motion. Its size makes it versatile for both domestic and public spaces, and the compartment is ideal for plants or medium size plant decorations.

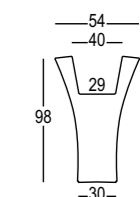

COLORI BASE / BASIC COLOURS

Art. 6204 | SHOCK

C2

84

86

87

LACCATI / LACQUERED

Art. 6504 | SHOCK

D7

07

86

METALLIZZATI / METALLIZED

Art. 6804 | SHOCK

C8



TAMBO

DESIGN
LUCA NICHETTO
2007



Vaso dalla superficie "vibrante" capace di creare dei preziosi giochi di luce soprattutto nella versione laccata. Le sue dimensioni lo rendono adatto a qualsiasi tipo di spazio pubblico o domestico, sia interno che esterno.

Vase with a "vibrant" surface capable of creating precious light games especially in the lacquered version. Its size makes it suitable for any type of domestic or public space, both internally and externally.

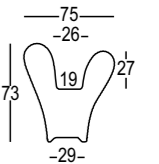

COLORI BASE / BASIC COLOURS

Art. 6222 | TAMBO

C2

C9

87

LACCATI / LACQUERED

Art. 6522 | TAMBO

D3

07

86

METALLIZZATI / METALLIZED

Art. 6822 | TAMBO

E8



T BALL POT

DESIGN
ALBERTO BROGLIATO
2010



Una fioriera/contenitore dalle forme morbide, versatile ed adattabile a molteplici contesti sia classici che contemporanei. Abbinato ad elementi aggiuntivi può assolvere a nuove funzioni (vedi pag. 62 del catalogo).

A soft shaped planter/container, versatile and adaptable to multiple contexts both classic and contemporary. Combined with additional elements can perform new functions (see pag. 62 catalogue).

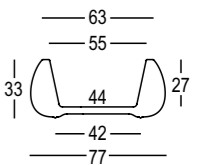

**COLORI BASE /
BASIC COLOURS**

Art. 6248 | T BALL POT

C2

G9

M9

N2

N4

87

**LACCATI /
LACQUERED**

Art. 6548 | T BALL POT

03

44

TONQUA

DESIGN
VALERIO TONEL
2007



Vaso dalla forma conica svasata, caratterizzato nella sezione superiore da una forma squadrata. Versatile e adatto a spazi sia interni che esterni. Ideale per piante o decorazioni vegetali di media dimensione.

Conical countersunk shaped vase, characterized on its upper side by a square shape. Versatile and suitable for both indoor and outdoor spaces. Ideal for plants or medium size plant decorations.

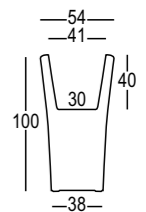

**COLORI BASE /
BASIC COLOURS**

Art. 6200 | TONQUA

84 

86 

87 

**LACCATI /
LACQUERED**

Art. 6500 | TONQUA

D7 

03 

07 

86 

**METALLIZZATI /
METALLIZED**

Art. 6800 | TONQUA

C8 



TROTTOLA

DESIGN
ILARIA MARELLI
2007



Coppia di vasi che possono vivere anche singolarmente. La base d'appoggio non è ortogonale al terreno e per questo motivo possono ruotare e cambiare superficie d'appoggio.

Pair of vases that can also live individually.

The support base is not orthogonal to the ground and, therefore, the vases can rotate.

COLORI BASE / BASIC COLOURS

Art. 6215 | TROTTOLA 28

Art. 6216 | TROTTOLA 98

D5 

L4 

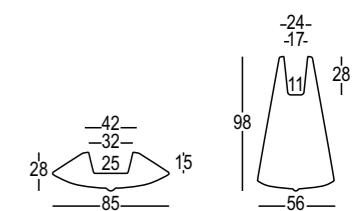

TROTTOLA 28

TROTTOLA 98

ACCESSORIES

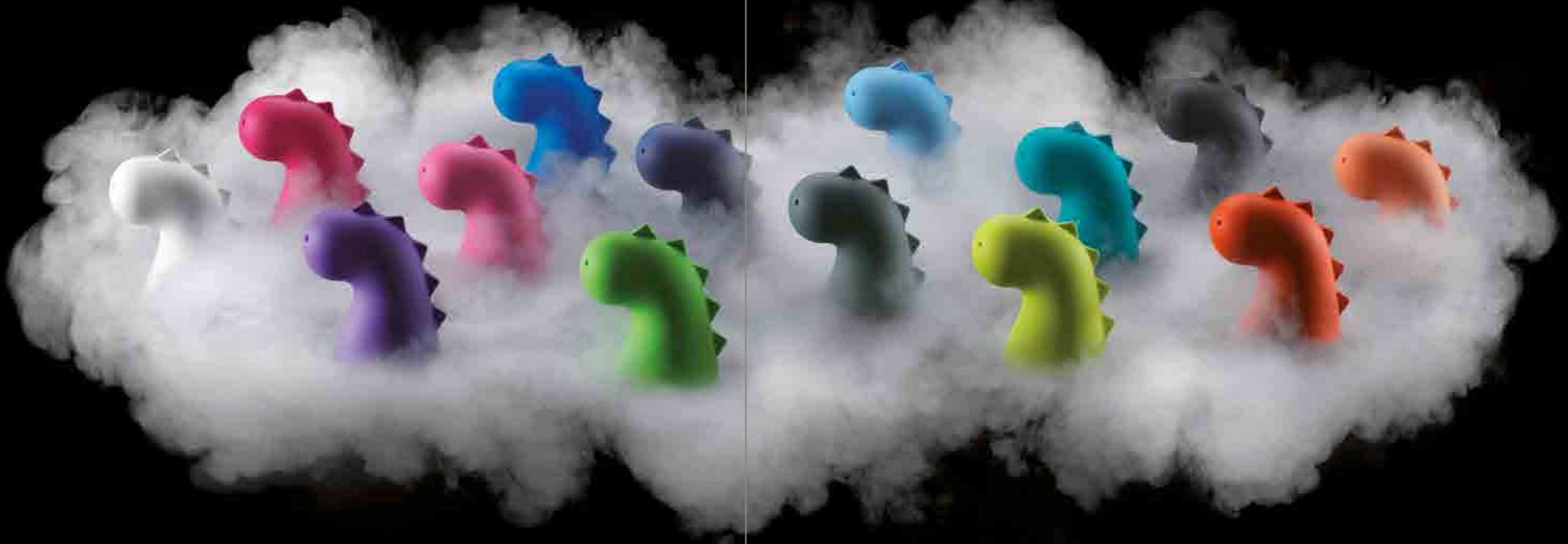

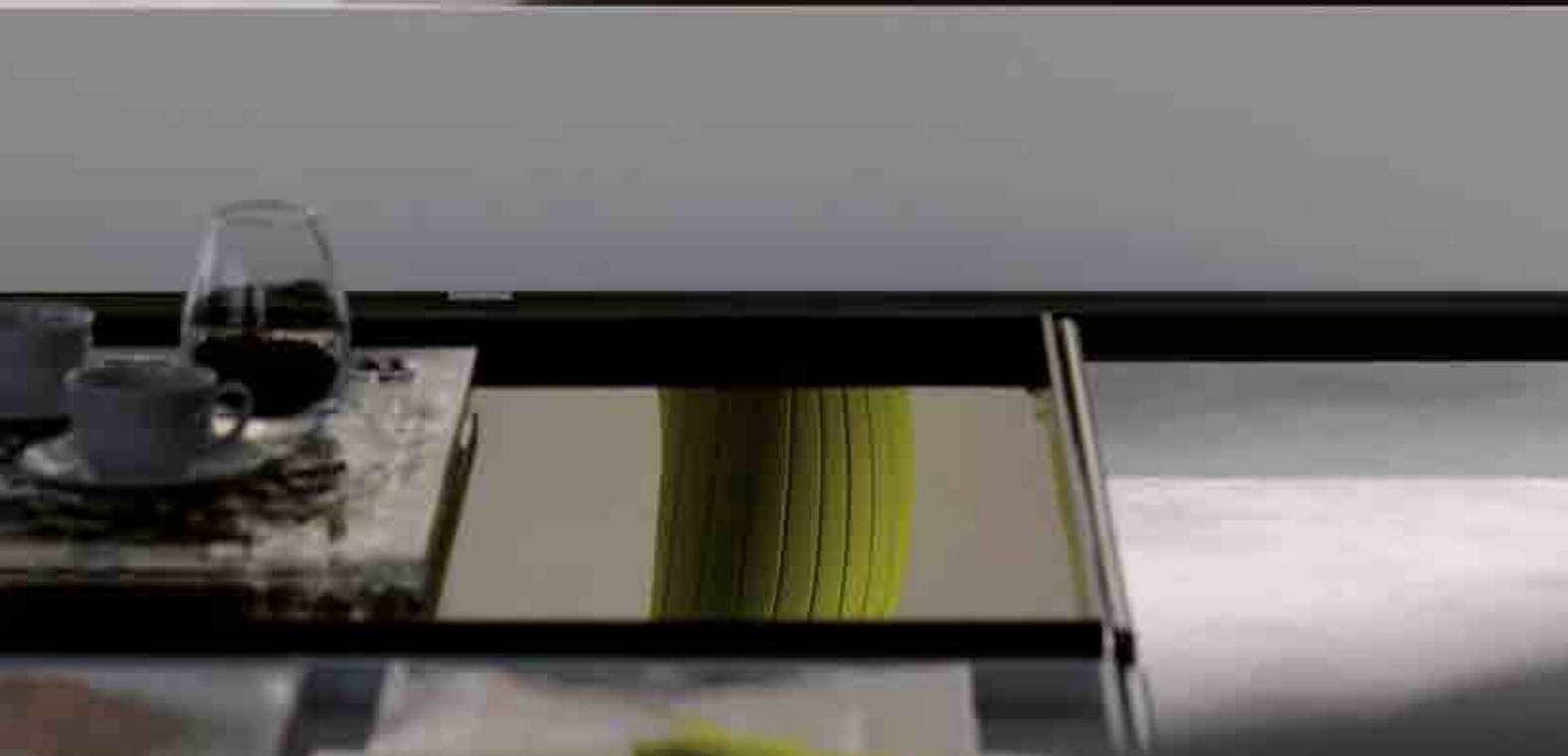

BADDY MINI BADDY

DESIGN
JOEVELLUTO (JVL) +
ALBERTO FABBIAN
2008



Versione **light** /
Light version



"Baddy" è una scultura in resina colorata adatta sia ad ambienti indoor che outdoor. In versione luminescente funge da "nano da guardia" grazie ad una resina luminescente che assorbe la luce per qualche istante, rilasciandola poi per svariate ore, facendolo diventare una piccola presenza nella notte. Disponibile su richiesta il sistema di fissaggio a terra.

"Baddy" is a colored resin sculpture suitable for outdoor and indoor settings. In the luminescent version it acts as a "dwarf guard" thanks to a luminous resin that absorbs light momentarily and then releases it for several hours, making it a small presence in the night. Available on request the fixing kit system.

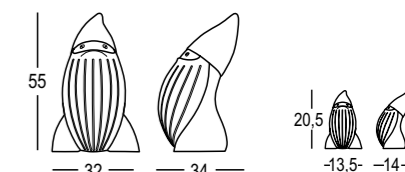

BADDY

MINI BADDY

**COLORI BASE /
BASIC COLOURS**

Art. 6242 | BADDY
Art. 6276 | MINI BADDY

C2

L4

74

86

87

**LACCATI /
LACQUERED**

Art. 6542 | BADDY

03

07

**METALLIZZATI /
METALLIZED**

Art. 6842 | BADDY

E7

**FINITURA SPECIALE /
SPECIAL FINISHING**

Art. 6942 | BADDY

E6

solo INDOOR / only INDOOR

Solo per indoor. Si consiglia l'uso indoor. In ambiente outdoor non esporre direttamente alla luce solare. **Only indoor.** We recommend indoor use. In the outdoor environment avoid directly solar light exposure.



BIGGIE

DESIGN
FILIPPO PROTASONI
2016



Versione **light** /
Light version



Un oggetto scultura che racconta la storia di una cinciallegra paffuta ed elegante. A metà tra astratto e figurativo, icona e cartoon, "Biggie" è un oggetto che arreda con eleganza gli spazi living. Realizzato in polietilene è disponibile in quattro versioni colore e in versione light, "Biggie" è un originale idea regalo per tutte le età.

A sculpture item that tells the story of a plump yet elegant great-tit that's half-way between abstract and figurative, icon and cartoon, "Biggie" furnishes spaces with elegance and irony. Made of polyethylene and available in four colour versions and in a light version, "Biggie" is an original gift idea for all ages.

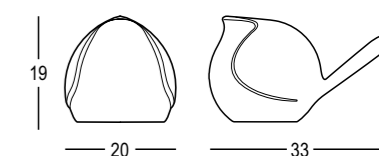

COLORI BASE / BASIC COLOURS

Art. 6351 | BIGGIE

A2 

A6 

C2 

70 



DRAGO DRAGHETTO

DESIGN
ALBERTO GHIRARDELLO
2015



Versione light /
Light version



"Drago" e "Draghetto" reinterpretano uno tra i personaggi di fantasia più iconici e affascinanti. La linea dal design contemporaneo li rende un'originale idea regalo per tutte le età. È disponibile in molteplici varianti colore, e in versione luminosa per illuminare e arredare con simpatia qualsiasi ambiente.

"Drago" and "Draghetto" are inspired by one of the most iconic and fascinating fictional characters. Their contemporary design makes them an original gift for any age. Available in various colours and the luminous version to light up and add a touch of fun to any room.

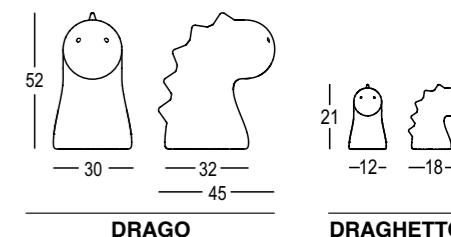

**COLORI BASE /
BASIC COLOURS**

Art. 6305 | DRAGO
Art. 6306 | DRAGHETTO

A2		11	
A9		16	
B1		43	
C1		74	
C2		86	
Q4		88	
08			

**LACCATI /
LACQUERED**

Art. 6505 | DRAGO

03

DRAGO

DRAGHETTO



GODOT

DESIGN
ALBERTO BROGLIATO
2011



Versione light /
Light version



Appendibili dai chiari riferimenti ad un mondo naturale e fantastico. Dotato di uno svuotatasche centrale ed appendici colorate intercambiabili di diversi colori, bene si può adattare ad uno spazio privato quanto ad un contesto pubblico quale sale d'attesa o hall di alberghi. Disponibile base di stabilizzazione o stabilizzazione e fissaggio - vedi sezione tecnica pag. 276.

"Godot" is a clothes stand that makes clear reference to a natural and fantastic world. Equipped with a central pocket emptier and coloured, interchangeable hangars of different colours, it can be adapted very well to a private area or to a public context alike, such as a waiting room or hotel foyer. Available a stability base or a stability and ground fixing base - see technical data pag. 276.

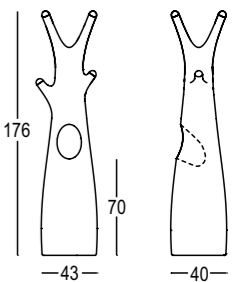

**COLORI BASE /
BASIC COLOURS**

Art. 6261 | GODOT

C2

G9

**LACCATI /
LACQUERED**

Art. 6561 | GODOT

03

**COLORI BASE /
BASIC COLOURS**

Art. A4315 | APPENDICI / ENDS

6 pezzi / 6 pieces

C2

D7

G9

86

87



GRADIENT 160

GRADIENT 180

DESIGN
MUT DESIGN
2012



Divisorio modulare composto da 2 pezzi di altezze diverse. L'accostamento dei moduli utilizzando le facce della base esagonale, permette di ricreare delle pareti di divisione degli spazi, più o meno regolari a seconda della necessità. Due o pochi elementi accostati possono dar vita inoltre a composizioni estremamente suggestive, creando piccoli giardini di fili d'erba fuori scala.

Modular partition made up of two pieces of different heights. The combination of modules using the sides of the hexagonal base allows you to create wall partitions to divide the spaces, in a more or less regular manner, depending on your needs. Two or just a few combined elements can also create some extremely suggestive compositions, creating small gardens of rows of out of scale grass.

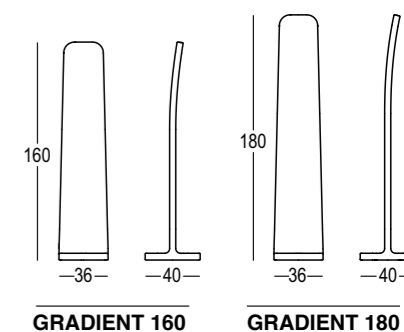

COLORI BASE / BASIC COLOURS

Art. 6272 | GRADIENT 160

Art. 6273 | GRADIENT 180

- A2
- B7
- C2
- 86



LAPSUS

DESIGN
EDDY ANTONELLO +
ALBERTO FABBIAN
2011





Appendiabiti free-standing che si erge solitario, ricordando le tipiche piante grasse del deserto. Dotato di 6 appigli, Lapsus è un oggetto ornamentale per la casa ma allo stesso tempo funzionale. La base in metallo permette una solida stabilità.

Freestanding clothes stand, reminiscent of the typical succulent plants of the desert. Equipped with six hangars, "Lapsus" is an ornamental object for the home, which is functional at the same time. The metal base ensures good stability.



**COLORI BASE /
BASIC COLOURS**

Art. 6260 | LAPSUS

- A9 
- C2 
- 86 

**LACCATI /
LACQUERED**

Art. 6560 | LAPSUS

- 03 
- 07 
- 86 

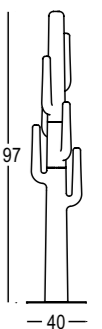



LEAF FLOWER

DESIGN
EMO DESIGN
2010



Steli decorativi in polietilene colorato che simulano grandi fiori stilizzati fuori scala. Offrono numerose possibilità di accostamento cromatico, permettendo di realizzare allestimenti d'effetto o arricchire spazi domestici con un tocco creativo. Ideale l'abbinamento con il vaso "Boyo" e "Drop" (vedi pag. 96, 106 del catalogo).

Decorative stems in colored polyethylene that imitates stylized flowers out of scale. Offers high potential for color match, leading to composition effects and enhance domestic spaces with a creative touch. Ideal the coupling with "Boyo" and "Drop" pots (see pag. 96, 106 catalogue).

COLORI BASE / BASIC COLOURS

Art. 6252 | LEAF

Art. 6251 | FLOWER

A5 

C2 

74 

86 

87 

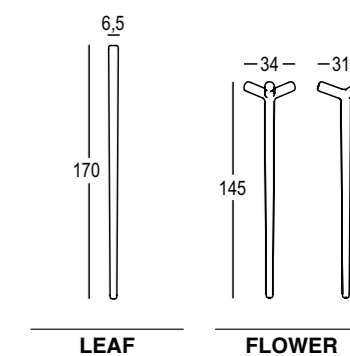

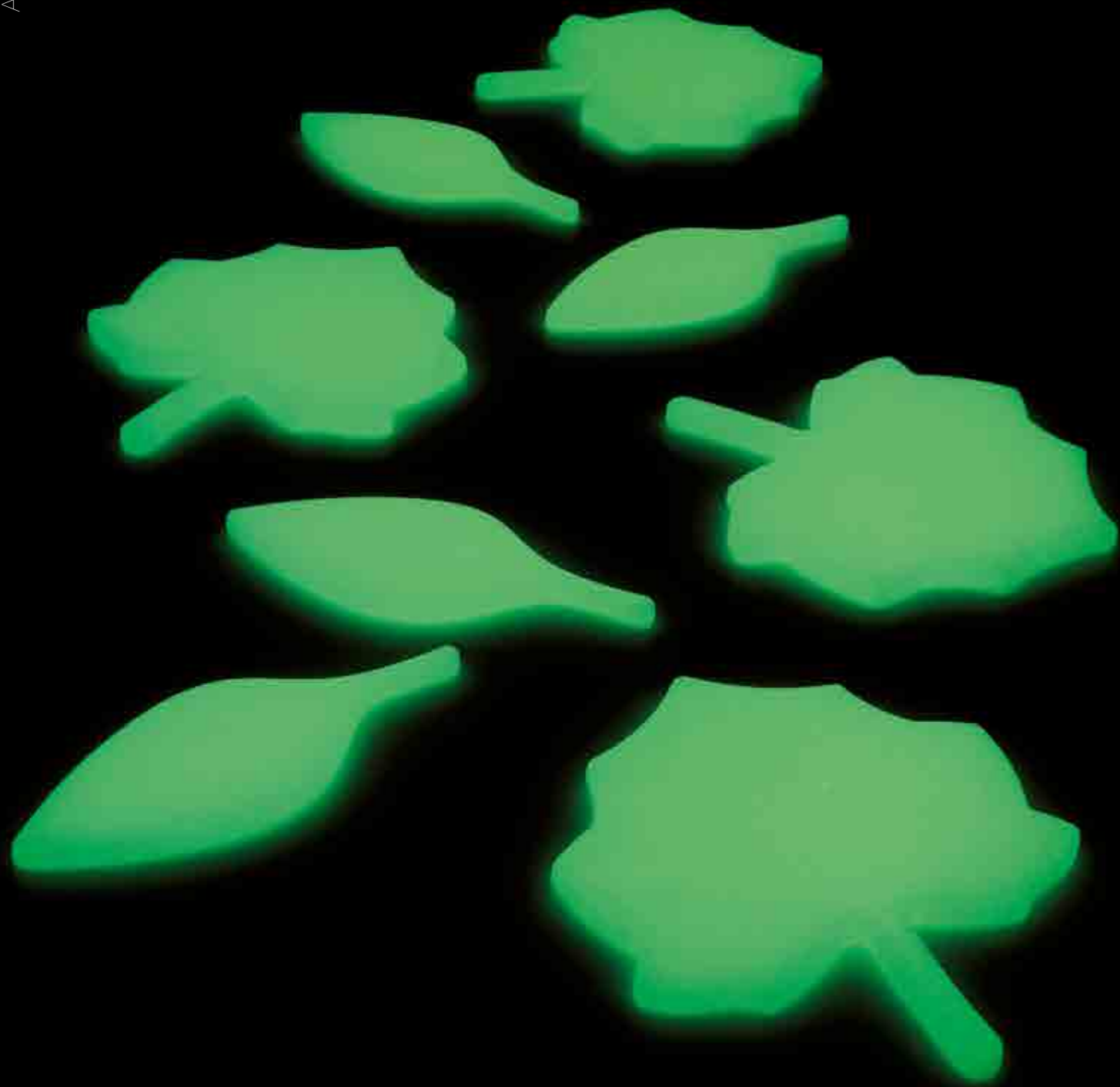

MOON-LEAVES 1 MOON-LEAVES 2

DESIGN
LAUDANI & ROMANELLI
2008

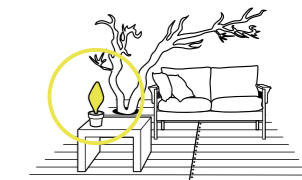
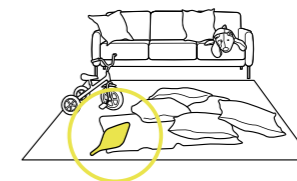
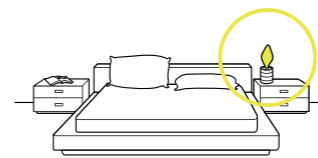
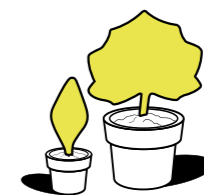

Maxi foglie stilizzate in polietilene luminescente che, assorbendo la luce durante il giorno, si "caricano" per poi offrire una luce soffusa durante la notte, diventando piacevoli decorazioni o utili segna passi. In ambiente outdoor non esporre direttamente alla luce solare.

Maxi stylized leaves in luminescent polyethylene. By absorbing light during the day, they load energy in order to offer a soft glow at night, creating pleasant decorations or becoming useful step marks. In the outdoor environment avoid directly solar light exposure.

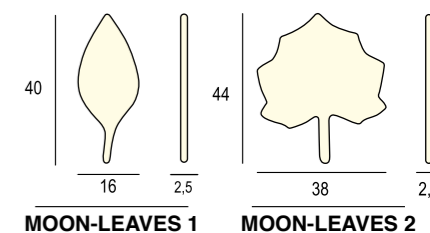

**FINITURA SPECIALE /
SPECIAL FINISHING**

Art. 6900 | MOON-LEAVES 1

Art. 6901 | MOON-LEAVES 2

E6

solo INDOOR / only INDOOR

Solo per indoor. Si consiglia l'uso indoor. In ambiente outdoor non esporre direttamente alla luce solare.
Only indoor. We recommend indoor use. In the outdoor environment avoid directly solar light exposure.

LIGHTS





BADDY LIGHT MINI BADDY LIGHT

DESIGN
JOVELLUTO (JMLT) +
ALBERTO FABBIAN
2008



Piccola scultura luminosa adatta ad ambienti indoor, facile da trasportare e versatile. Può essere utilizzata come lampada di cortesia in ambienti domestici, oppure come oggetto luminoso allegro e informale per personalizzare locali, camere d'albergo o ambienti di passaggio.

"Baddy Light" è disponibile in vari colori per adattarsi alle diverse tipologie di utilizzo e contesto.

Portable and versatile small luminous sculpture suitable for indoor environments. The "Baddy Light" can be used as a courtesy light in domestic environments, or as a cheerful and informal luminous object to customise rooms, hotel rooms or environments where there is traffic.

"Baddy Light" is available in various colours to adapt to the various types of uses and contexts.

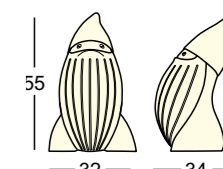

BADDY LIGHT

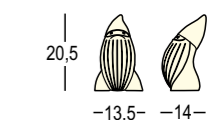

MINI BADDY LIGHT

INDOOR

Art. 8242 | BADDY LIGHT

Art. 8276 | MINI BADDY LIGHT

Completo di Kit Mini LED /
With Mini LED Kit

INDOOR

COLORI BASE / BASIC COLOURS

86 

98 

solo / only
BADDY LIGHT

74 

BARTOLOMEO LIGHT FAMILY

DESIGN
JOEVELLUTO (JVL)



BARTOLOMEO DESK LIGHT

DESIGN
JOEVELLUTO (JVL)
2013



BARTOLOMEO CORNER LIGHT

DESIGN
JOEVELLUTO (JVL)
2013



RGB LED COLOURS - vedi sezione tecnica / RGB LED COLOURS see technical data - pag. 282

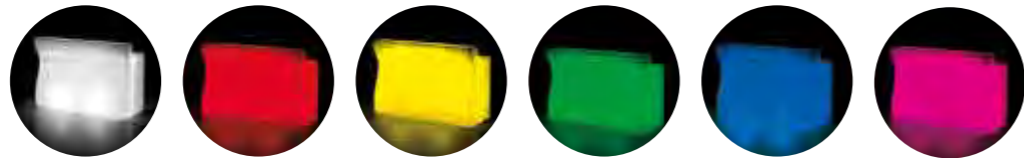

Bancone bar lineare utilizzabile come desk, consolle o banco bar a seconda della configurazione desiderata. È predisposto per alloggiare da 1 a 3 kit luce standard o con luce RGB, per ricreare atmosfere suggestive in situazioni di convivialità.

This linear counter can be used as a desk, console or bar counter, according to requirements. It is designed to house 1 to 3 standard or RGB lighting kits to create an evocative atmosphere in convivial settings.

INDOOR / OUTDOOR

- Art. 8277 | BARTOLOMEO DESK LIGHT
- Art. 8286 | BARTOLOMEO DESK LIGHT VERSION 1
- Art. 8287 | BARTOLOMEO DESK LIGHT VERSION 2
- Art. 8288 | BARTOLOMEO DESK LIGHT VERSION 3

Predisposto per Kit Luce ESTERNI /
Intended for OUTDOOR Light Kit

INDOOR / OUTDOOR

COLORI BASE / BASIC COLOURS

98

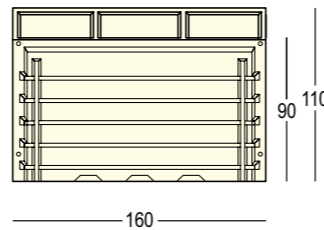
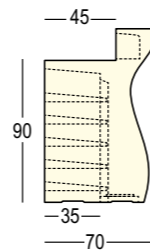

RGB LED COLOURS - vedi sezione tecnica / RGB LED COLOURS see technical data - pag. 282

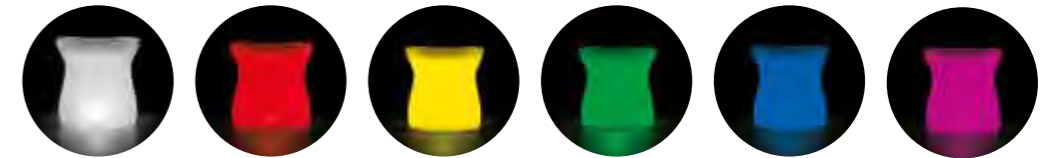

Modulo angolare accostabile all'elemento lineare per creare desk, consolle o banchi bar luminosi. Predisposto per alloggiare 1 kit luce standard o con luce RGB, utilizzato singolarmente o in coppia può dar vita ad avvolgenti reception illuminate.

This corner module can be paired with the linear one to create desks, consoles or luminous bar counters. It is designed to house 1 standard or RGB lighting kit. Use it alone or paired to create small, cosy, luminous reception areas.

INDOOR / OUTDOOR

- Art. 8278
BARTOLOMEO CORNER LIGHT

Predisposto per Kit Luce ESTERNI /
Intended for OUTDOOR Light Kit

INDOOR / OUTDOOR

COLORI BASE / BASIC COLOURS

98

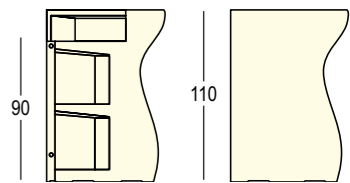
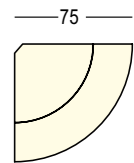



BARTOLOMEO DISPLAY LIGHT

DESIGN
JOEVELLUTO (JVL)
2014

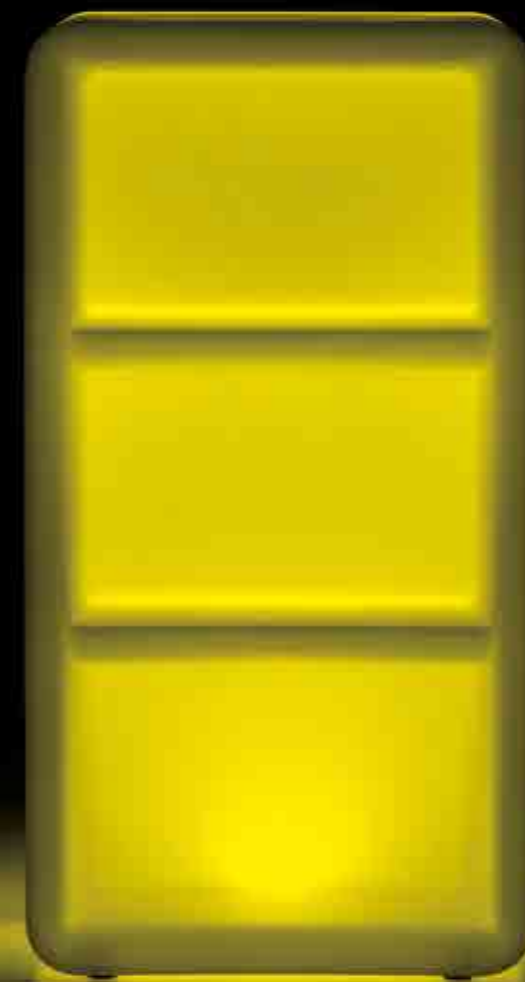

RGB LED COLOURS - vedi sezione tecnica / RGB LED COLOURS see technical data - pag. 282

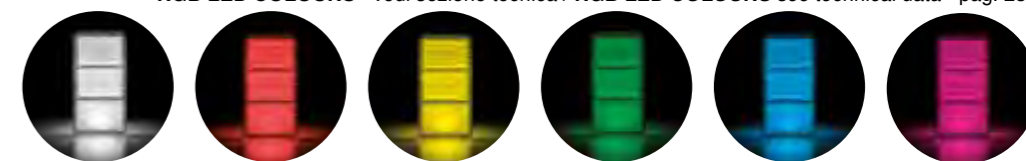

Display freestanding luminoso abbinato al bancone "Bartolomeo Light" adatto ad alloggiare strumenti da ristorazione e in particolar modo bottiglie e bicchieri in quanto, grazie all'illuminazione interna del display, anche gli oggetti in esso riposti vengono attraversati dalla luce, creando eleganti effetti di colore e trasparenze.

Luminous freestanding display matched with the "Bartolomeo Light" bar counter. Suitable for housing catering utensils, especially bottles and glasses. Thanks to the internal lighting system, every object is crossed by the light, thereby creating elegant colour and transparency effects.

INDOOR / OUTDOOR

Art. 9289
BARTOLOMEO DISPLAY LIGHT
Predisposto per Kit Luce ESTERNI /
Intended for OUTDOOR Light Kit

INDOOR / OUTDOOR

COLORI BASE / BASIC COLOURS
98

KIT GAMBE / LEGS KIT

Art. A4485
98

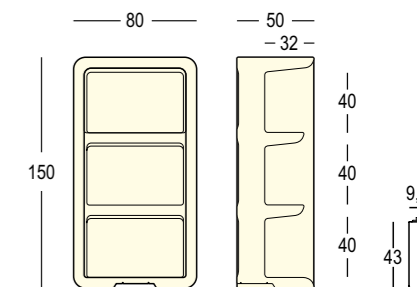

BIG CUT LIGHT FAMILY

DESIGN
MATALI CRASSET





BIG CUT ARMCHAIR LIGHT

DESIGN
MATALI CRASSET
2013

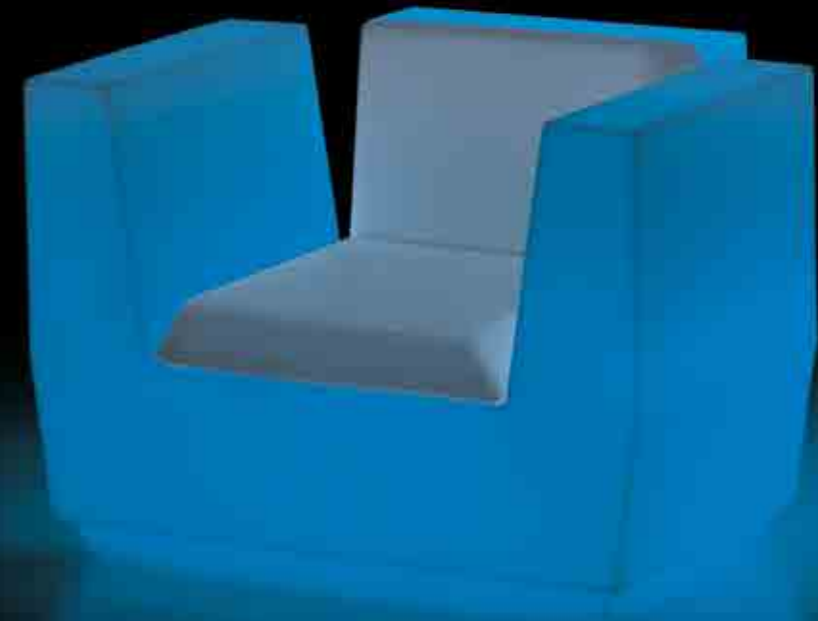

RGB LED COLOURS - vedi sezione tecnica / RGB LED COLOURS see technical data - pag. 282

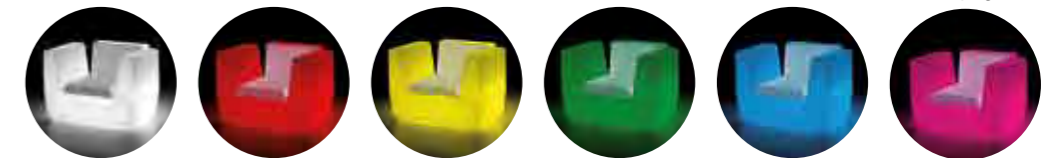

Comoda poltrona luminosa con braccioli, completa di cuscino in morbida ecopelle o tessuto tecnico, perfetta per ricreare suggestive composizioni sia in ambienti indoor che outdoor.
PER MAGGIORI INFORMAZIONI SUI CUSCINI: vedi sezione tecnica pag. 270

This luminous armchair, provided with a sky or technical fabric cushion, is perfect to create stunning compositions both indoors and outdoors.
FOR FURTHER INFORMATION ON THE CUSHIONS: see technical data section. 270

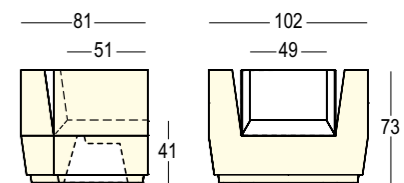

INDOOR / OUTDOOR

Art. 8279
BIG CUT ARMCHAIR LIGHT

Predisposto per / Intended for
INDOOR-OUTDOOR Light Kit

INDOOR / OUTDOOR

COLORI BASE / BASIC COLOURS

Ecopelle / Sky

L9

Tessuto tecnico / Technical fabric

M0

M1

BIG CUT CORNER LIGHT

DESIGN
MATALI CRASSET
2013

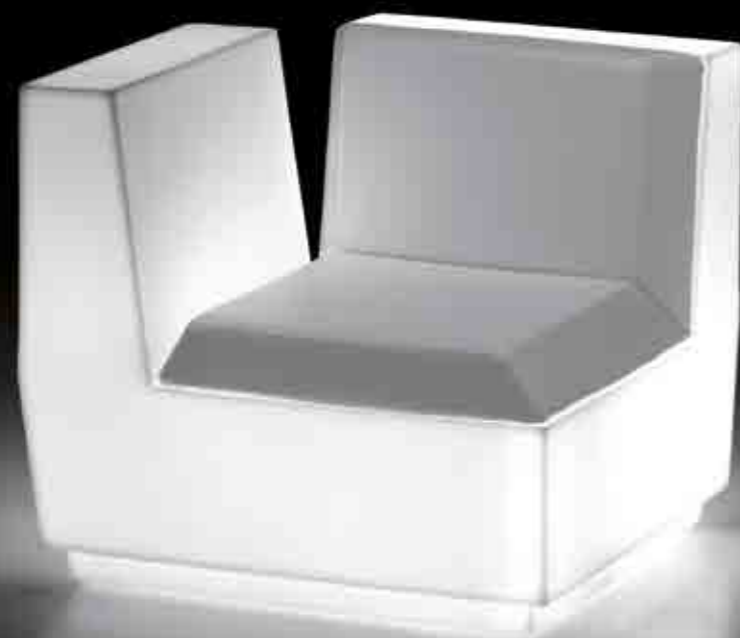

RGB LED COLOURS - vedi sezione tecnica / RGB LED COLOURS see technical data - pag. 282

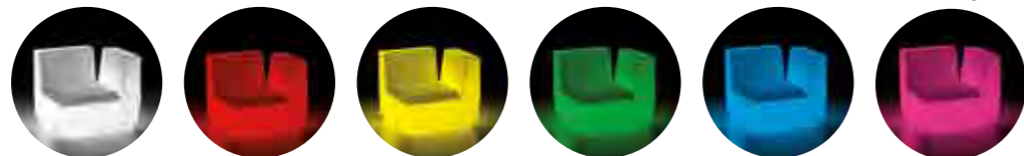

Angolo luminoso da utilizzare abbinato al sistema della famiglia "Big Cut", per creare infinite composizioni. Completati di cuscini adatti sia all'indoor che all'outdoor.
PER MAGGIORI INFORMAZIONI SUI CUSCINI: vedi sezione tecnica pag. 270

A luminous corner piece to be matched with the "Big Cut" family to create infinite compositions. Provided with cushions for both indoor and outdoor use.
FOR FURTHER INFORMATION ON THE CUSHIONS: see technical data section. 270

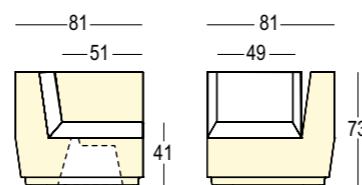

INDOOR / OUTDOOR	INDOOR / OUTDOOR
Art. 8281 BIG CUT CORNER LIGHT	COLORI BASE / BASIC COLOURS
Predisposto per / Intended for INDOOR-OUTDOOR Light Kit	Ecopelle / Sky
	L9 <input type="checkbox"/>
	Tessuto tecnico / Technical fabric
	M0 <input type="checkbox"/>
	M1 <input type="checkbox"/>

BIG CUT MODULE LIGHT

DESIGN
MATALI CRASSET
2013



RGB LED COLOURS - vedi sezione tecnica / RGB LED COLOURS see technical data - pag. 282

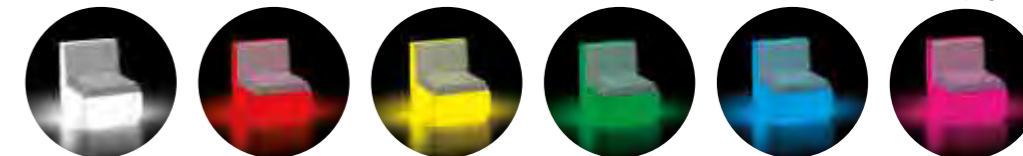

Modulo luminoso che può essere utilizzato singolarmente o accostato ad uno o più elementi della famiglia "Big Cut", generando un divano dalla proporzione lineare desiderata. Completati di cuscini adatti sia all'indoor che all'outdoor.
PER MAGGIORI INFORMAZIONI SUI CUSCINI: vedi sezione tecnica pag. 270

A luminous module that can be used alone or in combination with one or more elements of the "Big Cut" family to create a linear sofa with the desired proportions. Provided with cushions for both indoor and outdoor use.
FOR FURTHER INFORMATION ON THE CUSHIONS: see technical data section. 270

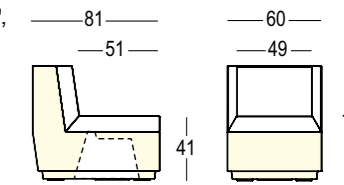

INDOOR / OUTDOOR	INDOOR / OUTDOOR
Art. 8280 BIG CUT MODULE LIGHT	COLORI BASE / BASIC COLOURS
Predisposto per / Intended for INDOOR-OUTDOOR Light Kit	Ecopelle / Sky
	L9 <input type="checkbox"/>
	Tessuto tecnico / Technical fabric
	M0 <input type="checkbox"/>
	M1 <input type="checkbox"/>



BIGGIE LIGHT

DESIGN
FILIPPO PROTASONI
2016

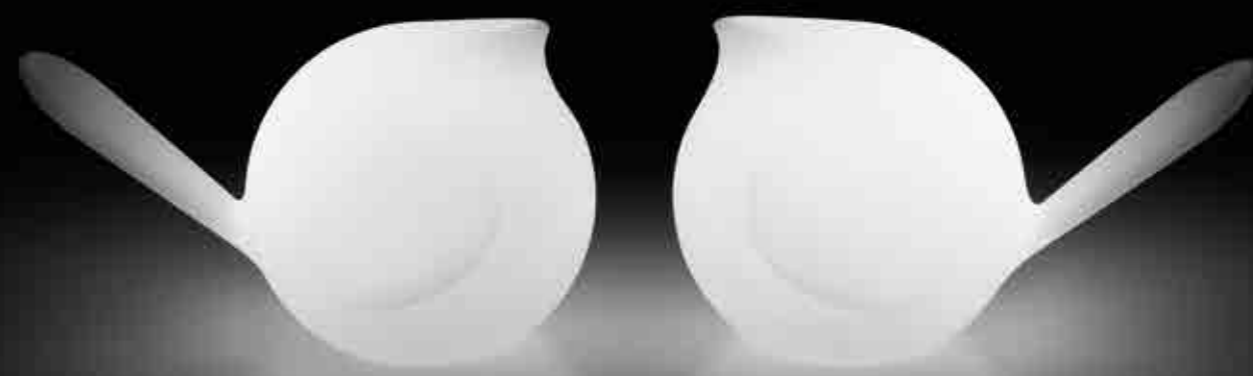

In versione luminosa, "Biggie" può essere utilizzata come lampada in ambienti domestici, oppure come oggetto luminoso per personalizzare locali, camere d'albergo e luoghi comuni. Un volume di luce morbida che illumina con simpatia. Adatta per ambienti indoor.

In the light version, "Biggie" can be used as a lamp in home environments, or as a lighting feature to personalize clubs, bars, hotel bedrooms and communal areas. A volume of soft light which pleasantly illuminates the zone. Suitable for indoor environments.

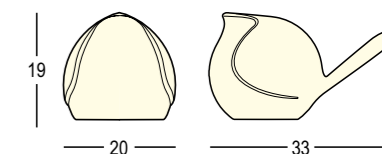

INDOOR

Art. 8351 | **BIGGIE LIGHT**

Completo di Kit Mini LED /
With Mini LED Kit

INDOOR

COLORI BASE / BASIC COLOURS

98



BOLD FAMILY LIGHT

DESIGN
GIULIO IACCHETTI



BOLD ARMCHAIR LIGHT BOLD SOFA LIGHT

DESIGN
GIULIO IACCHETTI
2016

BOLD TABLE LIGHT

DESIGN
GIULIO IACCHETTI
2016



RGB LED COLOURS - vedi sezione tecnica / RGB LED COLOURS see technical data - pag. 282



Comoda poltrona e divano luminosi. Assieme creano un sistema di sedute caratterizzate da linee morbide esaltate da una luce soffusa che crea una situazione d'atmosfera accogliente e particolarmente adatta per arredare spazi lounge.

PER MAGGIORI INFORMAZIONI SUI CUSCINI: vedi sezione tecnica pag. 272

Comfortable light armchair and sofa. Together, they create a system of seats characterized by curved lines enhanced by soft lighting that creates a welcoming atmosphere which is ideal for indoor lounge areas.

FOR FURTHER INFORMATION ON THE CUSHIONS: see technical data section. 272

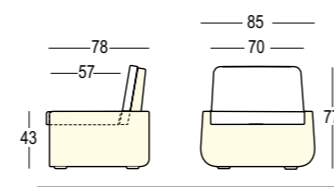

ARMCHAIR

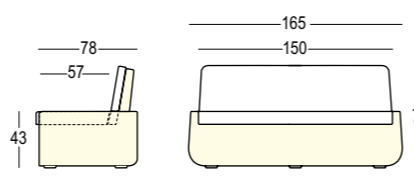

SOFA

INDOOR / OUTDOOR

Art. 8245 | 8211
BOLD ARMCHAIR LIGHT

Predisposto per / Intended for
INDOOR-OUTDOOR Light Kit

Art. 8212 | 8268
BOLD SOFA LIGHT

Predisposto per / Intended for
INDOOR-OUTDOOR Light Kit

INDOOR / OUTDOOR

COLORI BASE / BASIC COLOURS

Art. 8245 | **BOLD ARMCHAIR LIGHT**
Art. 8212 | **BOLD SOFA LIGHT**

Struttura / Structure

98

TESSUTO / FABRIC

White



INDOOR / OUTDOOR

COLORI BASE / BASIC COLOURS

Art. 8211 | **BOLD ARMCHAIR LIGHT**
Art. 8268 | **BOLD SOFA LIGHT**

Struttura / Structure

98

TESSUTO / FABRIC

Heather Grey



RGB LED COLOURS - vedi sezione tecnica / RGB LED COLOURS see technical data - pag. 282

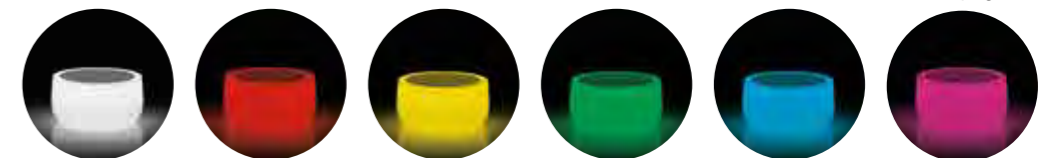

Coffe table luminoso che si abbina e completa la famiglia di arredi "Bold". Disponibile con piano in HPL, bianco o nero.

Light coffee table that matches and completes the "Bold" furnishings family. Available with HPL top white or black.

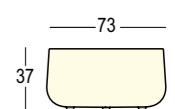

STRUCTURE

60

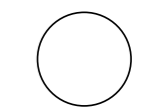

TOP

INDOOR / OUTDOOR

Art. 8344 | **BOLD TABLE LIGHT**

Predisposto per / Intended for
INDOOR-OUTDOOR Light Kit

INDOOR / OUTDOOR

COLORI BASE / BASIC COLOURS

98

PIANO / HPL

HPL - Rotondo / Round

Ø 60 - Art. A4463



Ø 60 - Art. A4464





BOYO LIGHT

DESIGN
GENTLE GIANTS
2012



Vaso luminoso adatto a creare dei grandi punti luce in ambienti indoor sia classici che contemporanei ma anche per arredare giardini, terrazzi, portici o spazi aperti. Necessita di base di stabilizzazione o stabilizzazione e fissaggio - vedi sezione tecnica pag. 278.

Luminous vase of imposing dimensions, with sinuous shapes: suitable to create large points of light in both classical and contemporary indoor environments, but also to furnish gardens, terraces, porticoes and open spaces. Need a stability base or a stability and ground fixing base - see technical data pag.278.

INDOOR / OUTDOOR

Art. 8270 | BOYO LIGHT INDOOR
Predisposto per Kit Luce INTERNI /
Intended for INDOOR Light Kit

Art. 9270 | BOYO LIGHT OUTDOOR
Predisposto per Kit Luce ESTERNI /
Intended for OUTDOOR Light Kit

INDOOR / OUTDOOR

COLORI BASE / BASIC COLOURS

98

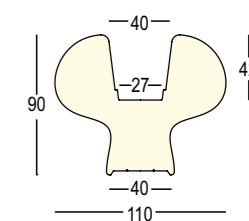

INDOOR

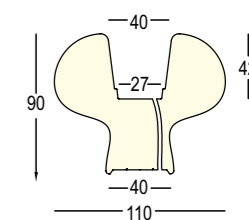

OUTDOOR

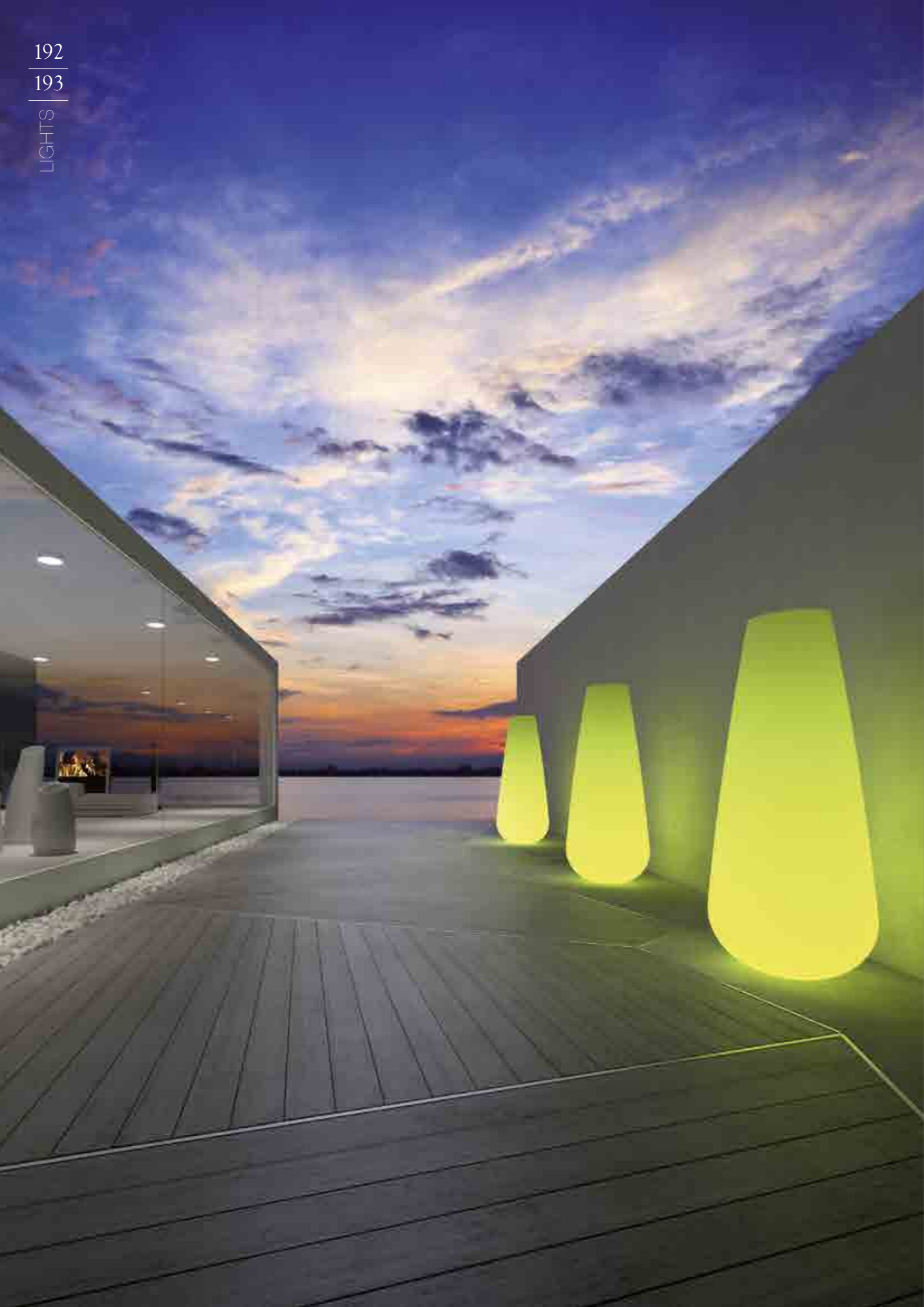

BUBA LIGHT

DESIGN
E3P DESIGN DEPT.
2007



RGB LED COLOURS - vedi sezione tecnica / RGB LED COLOURS see technical data - pag. 282

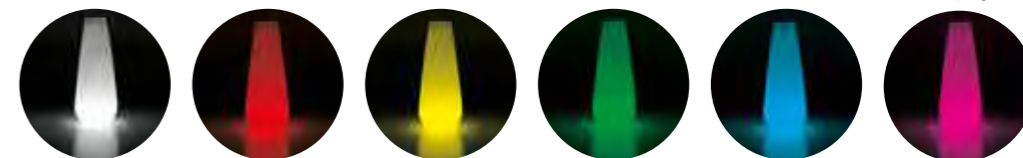

Vaso luminoso dalle forme archetipe. Adatto a creare situazioni di luce soffusa in aree di passaggio o spazi ampi, con le sue imponenti dimensioni contribuisce a creare soluzioni d'arredo di grande impatto.
Disponibile base di stabilizzazione o stabilizzazione e fissaggio - vedi sezione tecnica pag. 278

*Luminous vase with archetypal shapes. This vase is suitable to create situations of suffused light in areas with traffic or large areas; it contributes to creating furnishing solutions of great impact, with its imposing dimensions.
Available a stability base or a stability and ground fixing base - see technical data pag.278.*

INDOOR / OUTDOOR

Art. 8202 | BUBA LIGHT INDOOR

Predisposto per Kit Luce INTERNI /
Intended for INDOOR Light Kit

Art. 9202 | BUBA LIGHT OUTDOOR

Predisposto per Kit Luce ESTERNI /
Intended for OUTDOOR Light Kit

INDOOR / OUTDOOR

COLORI BASE / BASIC COLOURS

74

86

98

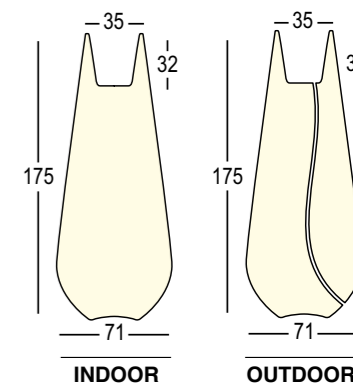

INDOOR

OUTDOOR



CUBALIBRE LIGHT

DESIGN
GIULIO IACCHETTI
2007



RGB LED COLOURS - vedi sezione tecnica / RGB LED COLOURS see technical data - pag. 282

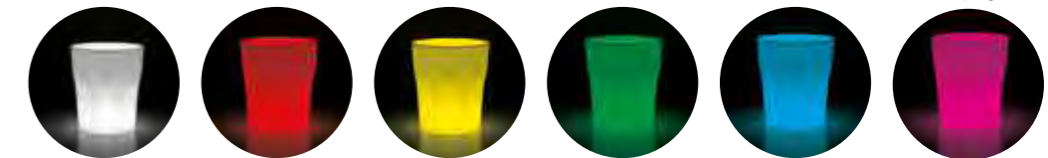

Allegro, sorprendente, casual è il vaso luminoso "Cubalibre" adatto a situazioni di convivialità in spazi pubblici di aggregazione.

Cheerful, surprising, is the casual pot light "Cubalibre" suitable for situations of coexistence in public spaces of aggregation.

INDOOR / OUTDOOR

Art. 8223
CUBALIBRE LIGHT INDOOR

Predisposto per Kit Luce INTERNI /
Intended for INDOOR Light Kit

Art. 9223
CUBALIBRE LIGHT OUTDOOR

Predisposto per Kit Luce ESTERNI /
Intended for OUTDOOR Light Kit

INDOOR / OUTDOOR

COLORI BASE / BASIC COLOURS

74 

86 

98 

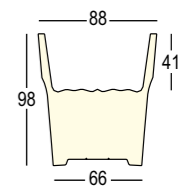

INDOOR

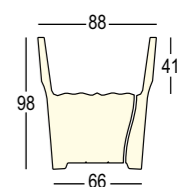

OUTDOOR

CUBALIBRE TABLE

DESIGN
GIULIO IACCHETTI
2015



RGB LED COLOURS - vedi sezione tecnica / RGB LED COLOURS see technical data - pag. 282

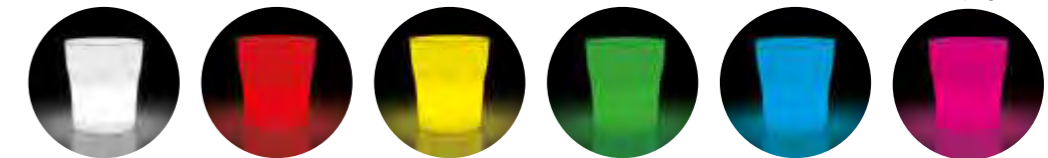

Versatile, resistente e pratico da pulire, è il tavolo luminoso "Cubalibre Table" munito di piano in diversi colori e materiali (HPL e PMMA opaco 60%), destinato ad arredare spazi conviviali creando scenografiche atmosfere.

Sturdy, versatile and easy to clean. This is the luminous "Cubalibre Table". Its top comes in various colours and materials (HPL and 60% matt PMMA) to furnish convivial settings and create a scenographic atmosphere.

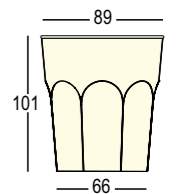

INDOOR / OUTDOOR

Art. 8296 | CUBALIBRE LIGHT
TOP HPL BIANCO / HPL WHITE

Predisposto per / Intended for
INDOOR-OUTDOOR Light Kit

Art. 8301 | CUBALIBRE LIGHT
TOP HPL NERO / HPL BLACK

Predisposto per Kit Luce / Intended for
INDOOR-OUTDOOR Light Kit

Art. 8302 | CUBALIBRE LIGHT
TOP PMMA NEUTRO / NEUTRAL

Predisposto per / Intended for
INDOOR-OUTDOOR Light Kit

INDOOR / OUTDOOR

COLORI BASE / BASIC COLOURS

Struttura / Structure

98

PIANO / TOP

HPL - High Pressure Laminate



DRAGO LIGHT DRAGHETTO LIGHT

DESIGN
ALBERTO GHIRARDELLO
2015



RGB LED COLOURS - vedi sezione tecnica / RGB LED COLOURS see technical data - pag. 282

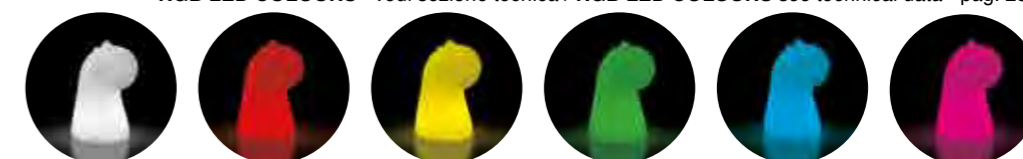

"Drago" in versione luminosa adatto ad ambienti indoor e outdoor, versatile e facile da trasportare. Può essere utilizzato come luce di cortesia in ambienti domestici, oppure come luce d'atmosfera informale per arredare qualsiasi tipologia di spazio. In versione "Draghetto", è una piccola abat-jour dotata di fonte luminosa a LED RGB, da utilizzare anche come luce di cortesia.

The luminous version of "Drago" is suitable for indoor and outdoor use and is versatile and easy to carry. It can be used as a courtesy light in domestic environments or to furnish any setting creating an informal atmosphere. The "Draghetto" version is a small lampshade with a white LED light kit, which can also be used as a courtesy light.

INDOOR / OUTDOOR - INDOOR

Art. 8352 | DRAGO LIGHT
INDOOR

Art. 8306 | DRAGHETTO LIGHT
INDOOR

Completo di Kit Mini LED /
With Mini LED Kit

Art. 8305 | DRAGO LIGHT
INDOOR / OUTDOOR

Predisposto per / Intended for
INDOOR-OUTDOOR Light Kit

INDOOR / OUTDOOR - INDOOR

COLORI BASE / BASIC COLOURS

74 

86 

98 

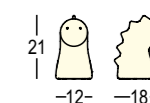

DRAGHETTO LIGHT

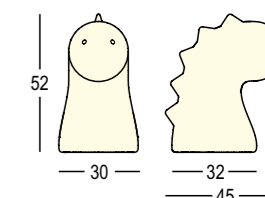

DRAGO LIGHT



DROP LIGHT

DESIGN
EMMANUEL BABLED
2010



RGB LED COLOURS - vedi sezione tecnica / RGB LED COLOURS see technical data - pag. 282

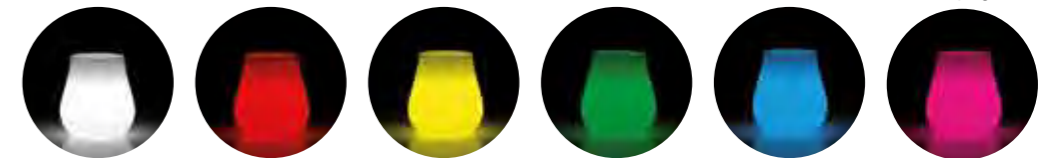

Vaso luminoso dalle dimensioni particolarmente versatili che lo rendono adatto a svariati contesti: da quello domestico, ad ambienti interni classici o contemporanei, ma anche per giardini, terrazzi, portici o spazi aperti.

Light pot with very versatile size that makes it suitable for a variety of contexts: from domestic interiors to classic or contemporary, but also for gardens, terraces, porches or open spaces.

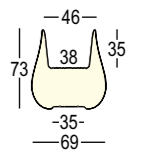

INDOOR

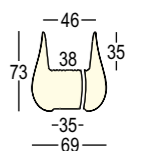

OUTDOOR

INDOOR / OUTDOOR

Art. 8254 | DROP LIGHT INDOOR

Predisposto per Kit Luce INTERNI /
Intended for INDOOR Light Kit

INDOOR / OUTDOOR

COLORI BASE / BASIC COLOURS

98

Art. 9254 | DROP LIGHT OUTDOOR

Predisposto per Kit Luce ESTERNI /
Intended for OUTDOOR Light Kit

FROZEN LIGHT FAMILY

DESIGN
MATTEO RAGNI +
MAURIZIO PRINA



FROZEN DESK LIGHT

DESIGN
MATTEO RAGNI +
MAURIZIO PRINA
2015



FROZEN CORNER LIGHT

DESIGN
MATTEO RAGNI +
MAURIZIO PRINA
2015

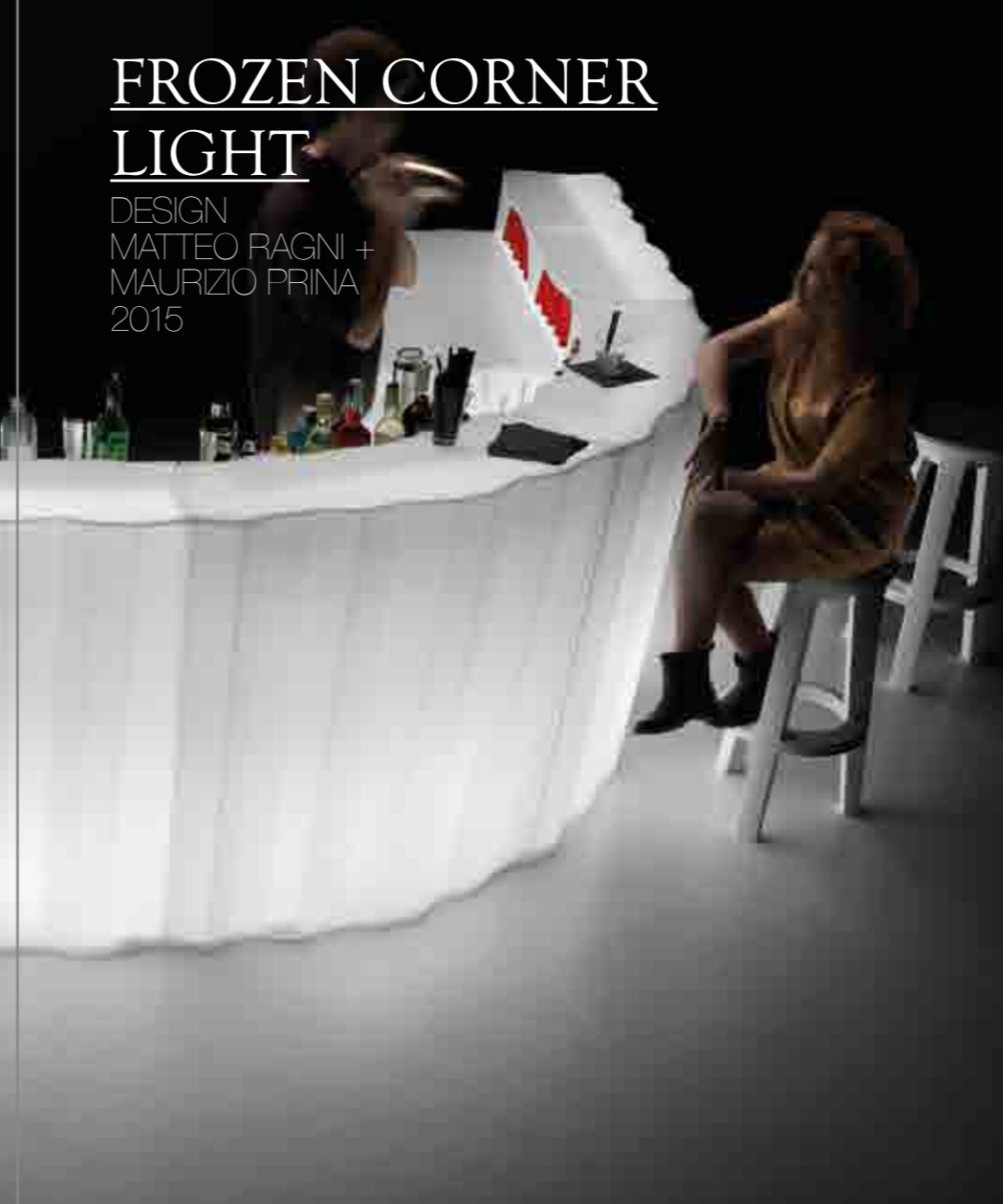

RGB LED COLOURS - vedi sezione tecnica / RGB LED COLOURS see technical data - pag. 282

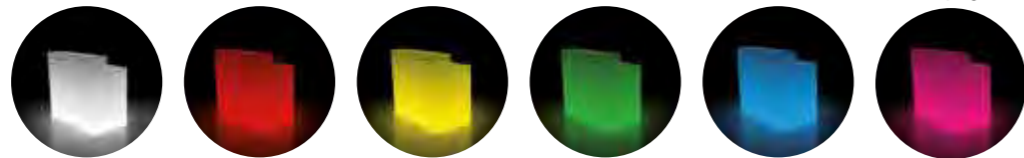

Bancone bar modulare luminoso, disponibile in due conformazioni di profondità, "Frozen Desk" e "Frozen Large" che permettono grande versatilità d'uso e impiego. La sfaccettatura superficiale che lo caratterizza in versione luminosa, crea delle rifrazioni di luce scenografiche e di grande impatto emozionale. Disponibile una completa gamma di accessori bar, adatto all'utilizzo sia in indoor che outdoor.

A luminous modular bar counter available in two depths, "Frozen Desk" and "Frozen Large", to ensure great versatility. The distinctive faceted surface of the luminous version creates spectacular refractions of great impact. Available with a full range of bar accessories. Suitable for indoor and outdoor use.

INDOOR / OUTDOOR

- Art. 8308 | FROZEN DESK LIGHT
- Art. 8320 | FROZEN DESK LIGHT VERSION 1
- Art. 8321 | FROZEN DESK LIGHT VERSION 2
- Art. 8316 | FROZEN DESK LARGE LIGHT

Predisposto per Kit Luce ESTERNI /
Intended for OUTDOOR Light Kit

INDOOR / OUTDOOR

COLORI BASE / BASIC COLOURS

98

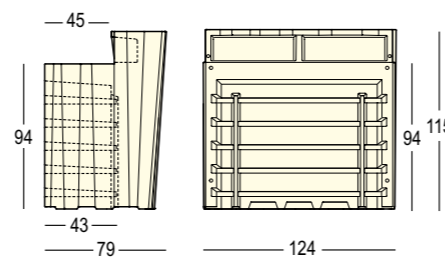

FROZEN DESK

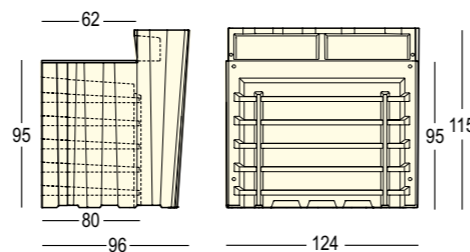

FROZEN LARGE

RGB LED COLOURS - vedi sezione tecnica / RGB LED COLOURS see technical data - pag. 282

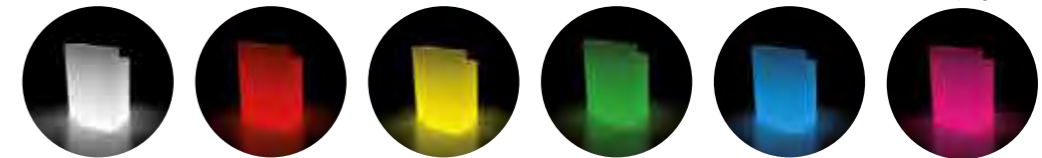

Modulo angolare accostabile all'elemento lineare per creare desk, consolle o banchi bar luminosi. Predisposto per alloggiare 1 kit luce standard o con luce RGB, utilizzato in coppia può dar vita ad avvolgenti reception illuminate.

This corner module can be paired with the linear one to create desks, consoles or luminous bar counters. It is designed to house 1 standard or RGB light kit. When paired, it creates fascinating luminous reception areas.

INDOOR / OUTDOOR

- Art. 8309 | FROZEN CORNER LIGHT
- Predisposto per Kit Luce ESTERNI /
Intended for OUTDOOR Light Kit

INDOOR / OUTDOOR

COLORI BASE / BASIC COLOURS

98

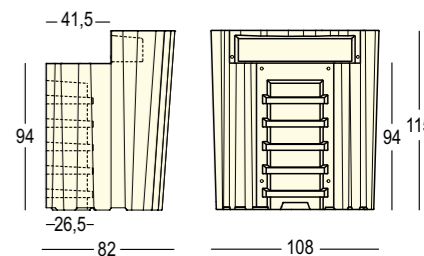
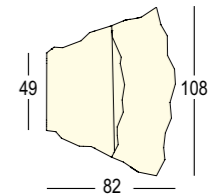



FROZEN DISPLAY LIGHT

DESIGN
MATTEO RAGNI +
MAURIZIO PRINA
2016



RGB LED COLOURS - vedi sezione tecnica / RGB LED COLOURS see technical data - pag. 282

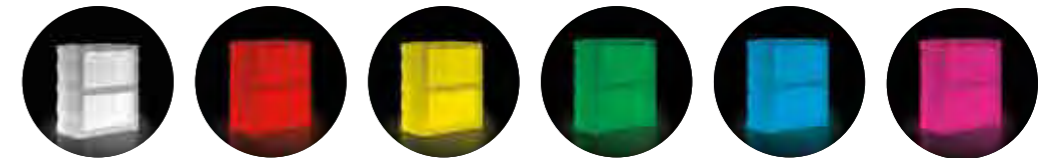

Disponibile nella versione light, ogni modulo è fornito di illuminazione indipendente per creare pareti di luce dove trovano funzionale alloggio tutti gli strumenti per il bar, bottiglie e bicchieri. Elemento free standing modulare, "Frozen Display Light" anima l'atmosfera dell'ambiente notturno con mutevoli geometrie di luce.

Available in the light version, each module has independent lighting, to create light walls where all the tools for the bar, bottles and glasses find easy and functional lodging places. "Frozen Display Light" is a free-standing modular item which livens up the night-time atmosphere with its changing geometrical light patterns.

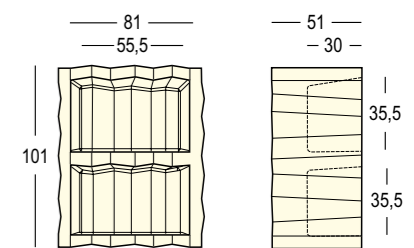

INDOOR / OUTDOOR

Art. 9338 | FROZEN DISPLAY LIGHT

Predisposto per Kit Luce ESTERNI /
Intended for OUTDOOR Light Kit

INDOOR / OUTDOOR

COLORI BASE / BASIC COLOURS

98

FROZEN TABLE LIGHT

DESIGN
MATTEO RAGNI +
MAURIZIO PRINA
2015



RGB LED COLOURS - vedi sezione tecnica / RGB LED COLOURS see technical data - pag. 282

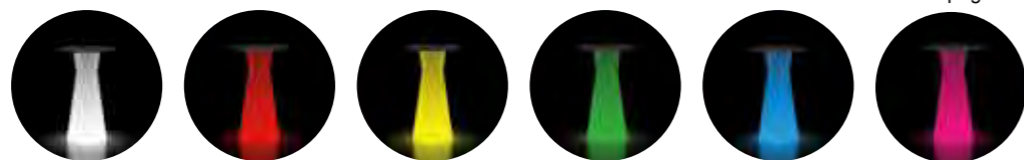

Tavolo alto a base centrale al si possono abbinare piani in HPL di dimensioni e colori diversi per diverse esigenze funzionali ed estetiche. Con l'accostamento di più "Frozen Table" abbinati al piano quadrato, è possibile creare scenografici tavoli buffet e svariate soluzioni d'arredo per incontrare le esigenze più comuni degli spazi pubblici.

High table with a central base that can be combined with HPL tops in different sizes and colours for any functional and aesthetic requirement. By joining several "Frozen Table" with a square top, you can create spectacular buffet tables and numerous solutions to meet the requirements of the most common public spaces.

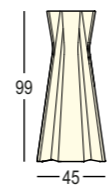

STRUCTURE

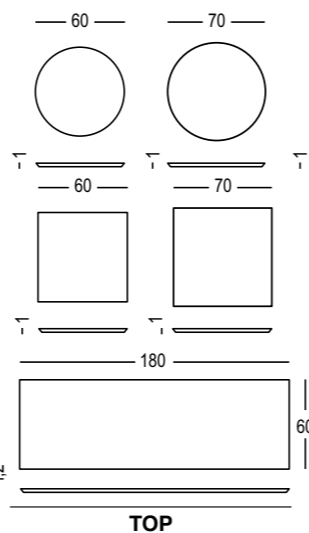

INDOOR / OUTDOOR	PIANO / TOP	PIANO / TOP
Art. 8310 FROZEN TABLE LIGHT	HPL - Rotondo / Round	HPL - Rotondo / Round
Predisposto per / Intended for INDOOR-OUTDOOR Light Kit	Ø 60 - Art. A4464 Ø 70 - Art. A4491	Ø 60 - Art. A4463 Ø 70 - Art. A4490
COLORI BASE / BASIC COLOURS	HPL - Quadrato / Square	HPL - Quadrato / Square
Struttura tavolo / Table structure	60x60 - Art. A4469 70x70 - Art. A4489	60x60 - Art. A4468 70x70 - Art. A4488
98 <input type="checkbox"/>	HPL - Rettangolare / Rectangular	HPL - Rettangolare / Rectangular
	180x60 - Art. A4471	180x60 - Art. A4470
	<input type="checkbox"/>	<input type="checkbox"/>

FROZEN DINING TABLE LIGHT

DESIGN
MATTEO RAGNI +
MAURIZIO PRINA
2015



RGB LED COLOURS - vedi sezione tecnica / RGB LED COLOURS see technical data - pag. 282

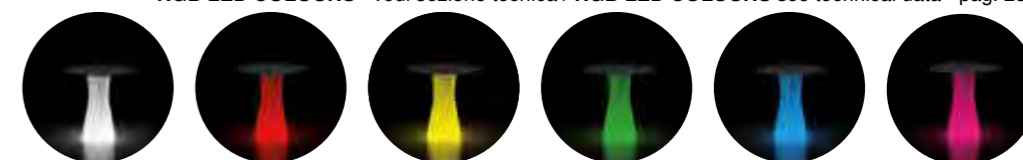

Dining table, composto da una base centrale luminosa abbinata a piani in HPL di dimensioni e colori diversi. Crea scenografici allestimenti di sala per ambienti bar e ristoranti.

A dining table with a central base matched with HPL tops in various sizes and colours. Perfect for creating a fascinating atmosphere in bars and restaurants.

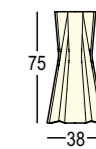

STRUCTURE

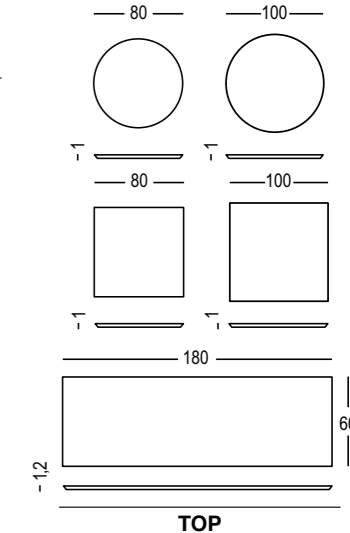

INDOOR / OUTDOOR	PIANO / TOP	PIANO / TOP
Art. 8311 FROZEN DINING TABLE LIGHT	HPL - Rotondo / Round	HPL - Rotondo / Round
Predisposto per / Intended for INDOOR-OUTDOOR Light Kit	Ø 80 - Art. A4495 Ø 100 - Art. A4499	Ø 80 - Art. A4494 Ø 100 - Art. A4498
COLORI BASE / BASIC COLOURS	HPL - Quadrato / Square	HPL - Quadrato / Square
Struttura tavolo / Table structure	80x80 - Art. A4493 100x100 - Art. A4497	80x80 - Art. A4492 100x100 - Art. A4496
98 <input type="checkbox"/>	HPL - Rettangolare / Rectangular	HPL - Rettangolare / Rectangular
	180x60 - Art. A4471	180x60 - Art. A4470
	<input type="checkbox"/>	<input type="checkbox"/>



FROZEN LAMP LIGHT

DESIGN
MATTEO RAGNI +
MAURIZIO PRINA
2016



RGB LED COLOURS - vedi sezione tecnica / RGB LED COLOURS see technical data - pag. 282

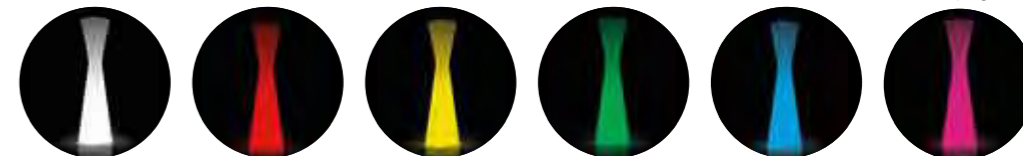

Un volume luminoso atemporale, caratterizzato dalle sfaccettature proprie della collezione "Frozen". Una forma slanciata, dalla base conica che da stabilità, risulta una lampada funzionale per creare ambientazioni di luce molto caratterizzanti. Adatta per ambienti indoor e outdoor. Disponibile base di stabilizzazione o stabilizzazione e fissaggio - vedi sezione tecnica pag. 278.

A timeless light item characterized by the facets of the "Frozen" collection. Sporting a slender shape given by the stable conical base, this functional lamp creates highly characteristic environments. Suitable for indoor and outdoor settings. Available a stability base or a stability and ground fixing base - see technical data pag. 278.

INDOOR / OUTDOOR

Art. 8339 I FROZEN LAMP LIGHT

Predisposto per / Intended for
INDOOR-OUTDOOR Light Kit

INDOOR / OUTDOOR

COLORI BASE / BASIC COLOURS

98

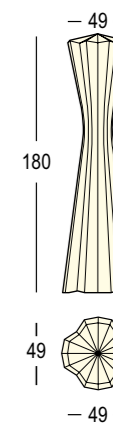



FOUR LAMP LIGHT

DESIGN
PHILIPPE TABET
2016



RGB LED COLOURS - vedi sezione tecnica / RGB LED COLOURS see technical data - pag. 282

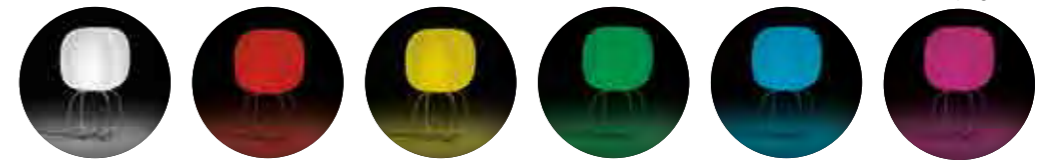

La famiglia di lampade "Four" si compone di una versione a sospensione, una da terra alta e una da terra bassa. La morbidezza e la sinuosità della lampada "Four" si esprimono tanto nella forma quanto nei giochi di luce, resi possibili grazie ad un'innovazione tecnica che, sfruttando la plastica stampata in rotazionale, permette di variarne gli spessori. Un volume plasmato a partire dall'effetto della luce sulla plastica, abbinabile a delle basi realizzate in acciaio inox che ne riprendendo la linea del diffusore.

The family of the "Four" lamps comes in pendant, standing and low-floor versions. The grace and sinuous lines of this lamp are conveyed as much in its shapes as in its lighting effect, which are made possible using a new rotational molding technology to vary the thicknesses. Volumes are created starting from the light plays on the plastic, which can be combined with stainless steel bases that match the line of the diffuser. "Four" is an elegant lamp that's just perfect for creating functional lighting moods both indoors and outdoors.

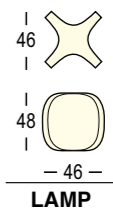

INDOOR / OUTDOOR

Art. 6353 | FOUR LAMP LIGHT

Predisposto per / Intended for
INDOOR-OUTDOOR Light Kit

COLORI BASE / BASIC COLOURS

98

Art. A4591 | HIGH STRUCTURE

Struttura in metallo / Metal structure

Art. A4592 | LOW STRUCTURE

Struttura in metallo / Metal structure

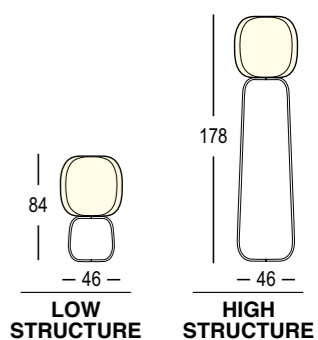

FURA LIGHT FAMILY

DESIGN
FORM US WITH LOVE



FURA STOOL LIGHT

DESIGN
FORM US WITH LOVE
2014



RGB LED COLOURS - vedi sezione tecnica / RGB LED COLOURS see technical data - pag. 282

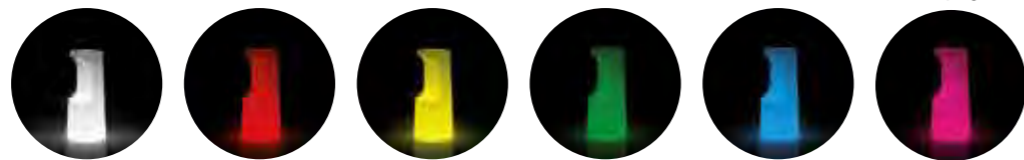

Sgabello luminoso in polietilene stampato in rotomoulding, dalle linee essenziali troncoconiche, versatile e adattabile ad ogni contesto di stile e gusto, grazie anche al kit di illuminazione a LED dotato di batteria, che elimina i cavi di alimentazione e rende completamente indipendente ogni elemento.

A luminous stool made of rotomoulded polyethylene and featuring an essential truncated-cone shape. Fura Stool Light is versatile and adapts to any style and taste, thanks to the battery-powered LED lighting kit, which eliminates the need for power cords and makes every element independent.

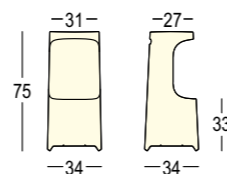

INDOOR / OUTDOOR

Art. 8294 | FURA STOOL LIGHT

Predisposto per / Intended for
INDOOR-OUTDOOR Light Kit

INDOOR / OUTDOOR

COLORI BASE / BASIC COLOURS

98

FURA TABLE LIGHT

DESIGN
FORM US WITH LOVE
2014



RGB LED COLOURS - vedi sezione tecnica / RGB LED COLOURS see technical data - pag. 282

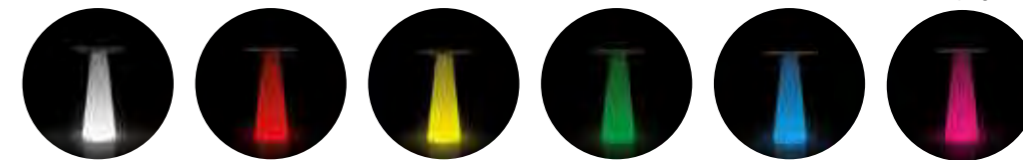

Tavolo a base centrale in polietilene stampato in rotomoulding, illuminato da un kit a LED dotato di batteria che elimina i cavi di alimentazione. Abbinabile a piani in HPL di diversi colori, utilizzabili sia in indoor che outdoor.

A table with a central rotomoulded polyethylene base lit by a battery-powered LED kit, which eliminates the need for power cords. It can be matched with HPL tabletops in various colours, suitable for both indoor and outdoor use.

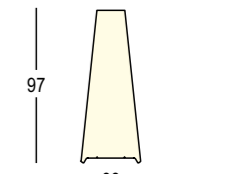

INDOOR / OUTDOOR

Art. 8295 | FURA TABLE LIGHT

Predisposto per / Intended for
INDOOR-OUTDOOR Light Kit

COLORI BASE / BASIC COLOURS

Struttura tavolo / Table structure

98

PIANO / TOP

HPL - Rotondo / Round

Ø 60 - Art. A4464

HPL - Quadrato / Square

60x60 - Art. A4469

HPL - Rettangolare / Rectangular

180x60 - Art. A4471



PIANO / TOP

HPL - Rotondo / Round

Ø 60 - Art. A4463

HPL - Quadrato / Square

60x60 - Art. A4468

HPL - Rettangolare / Rectangular

180x60 - Art. A4470



STRUCTURE

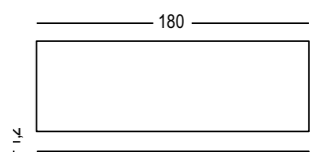
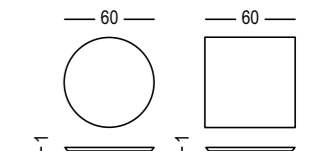

TOP



GODOT LIGHT

DESIGN
ALBERTO BROGLIATO
2011



RGB LED COLOURS - vedi sezione tecnica / RGB LED COLOURS see technical data - pag. 282

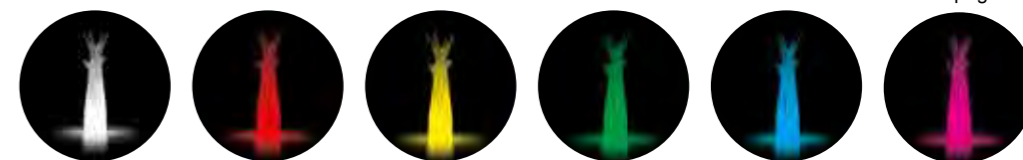

Appendiabiti/svuotatasche che rievoca la forma stilizzata di un albero. La luce in esso contenuta contribuisce a ricreare un'atmosfera fiabesca all'interno dello spazio nel quale viene collocato.
Disponibile base di stabilizzazione o stabilizzazione e fissaggio - vedi sezione tecnica pag. 278.

*Clothes stand/pocket emptier, reminiscent of the stylised form of a tree. The light contained in this element contributes to the creation of a fairy tale-like atmosphere in the area where it is placed.
Available a stability base or a stability and ground fixing base - see technical data pag. 278.*

INDOOR

Art. 8261 | GODOT LIGHT INDOOR

Predisposto per Kit Luce INTERNI /
Intended for INDOOR Light Kit

INDOOR

COLORI BASE / BASIC COLOURS

98

COLORI BASE / BASIC COLOURS

Art. A4315 | APPENDICI / ENDS

6 pezzi / 6 pieces

C2

D7

G9

86

87

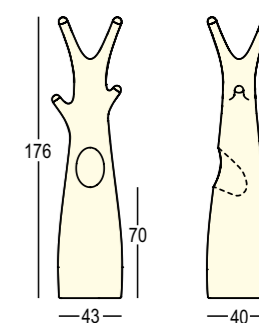



GUMBALL ARMCHAIR LIGHT

DESIGN
ALBERTO BROGLIATO
2009



RGB LED COLOURS - vedi sezione tecnica / RGB LED COLOURS see technical data - pag. 282

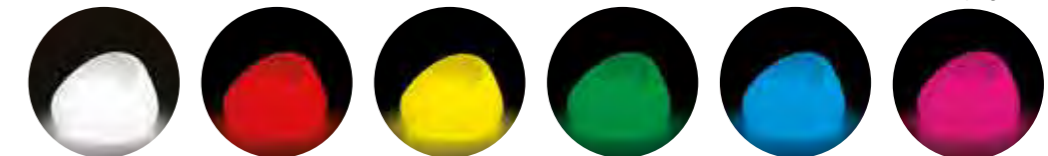

Seduta informale luminosa per spazi esterni. La luce soffusa contribuisce a creare una situazione d'atmosfera accogliente e particolarmente adatta a spazi pubblici e contract.

Informal lightning outdoor seat. The dim lighting helps create a situation of atmosphere, suited to public spaces and contract.

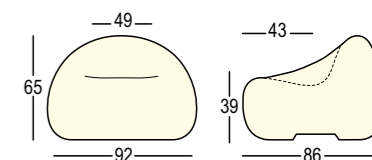

INDOOR / OUTDOOR

Art. 8246
GUMBALL ARMCHAIR LIGHT

Rigido / Hard

Predisposto per Kit Luce ESTERNI /
Intended for OUTDOOR Light Kit

INDOOR / OUTDOOR

COLORI BASE / BASIC COLOURS

98



GUMBALL SOFA LIGHT

DESIGN
ALBERTO BROGLIATO
2011

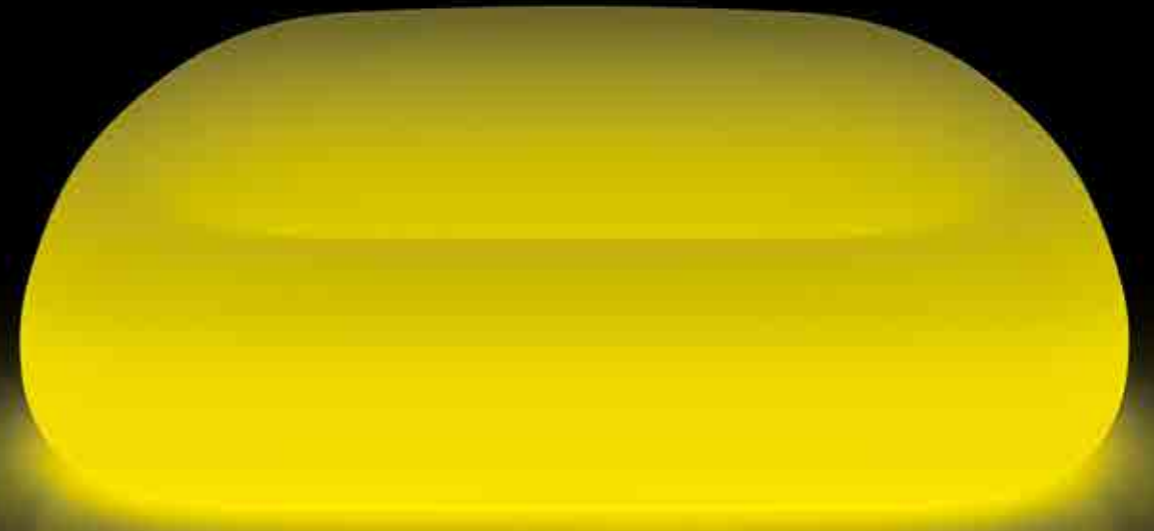

RGB LED COLOURS - vedi sezione tecnica / RGB LED COLOURS see technical data - pag. 282

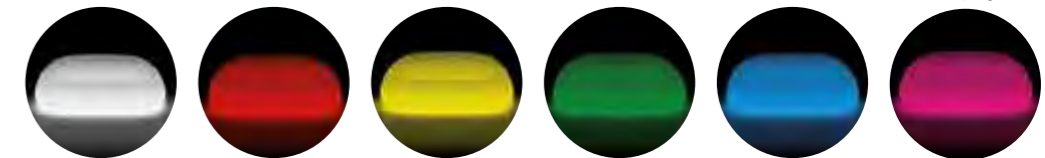

Divanetto informale dalle forme sinuose, avvolgenti e confortevoli.
La luce soffusa contribuisce a creare una situazione d'atmosfera accogliente e particolarmente adatta a spazi pubblici e contract.

Informal sofa with sinuous, embracing and comfortable forms. The suffused light contributes to the creation of a warm atmosphere, particularly suitable for public and contract spaces.

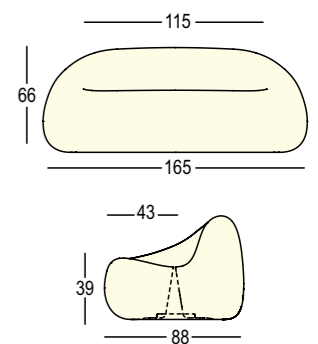

INDOOR / OUTDOOR

Art. 8263 | GUMBALL SOFA LIGHT

Rigido / Hard

Predisposto per Kit Luce ESTERNI /
Intended for OUTDOOR Light Kit

INDOOR / OUTDOOR

COLORI BASE / BASIC COLOURS

98

T BALL LIGHT

DESIGN
ALBERTO BROGLIATO
2010

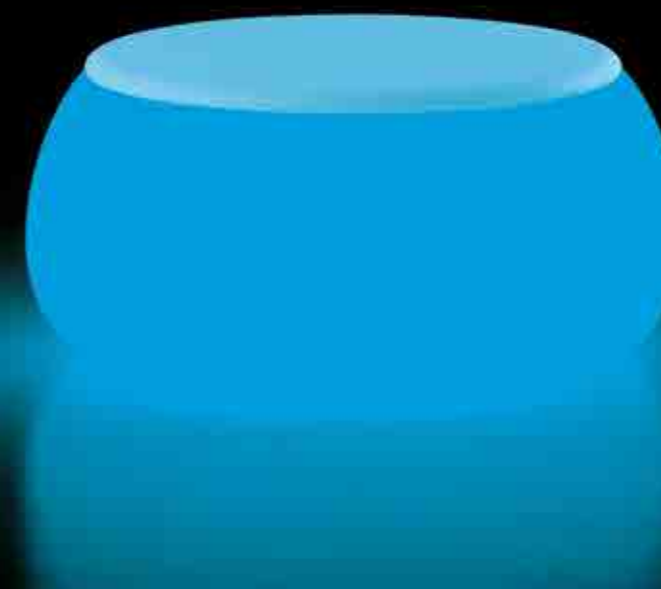

RGB LED COLOURS - vedi sezione tecnica / RGB LED COLOURS see technical data - pag. 282

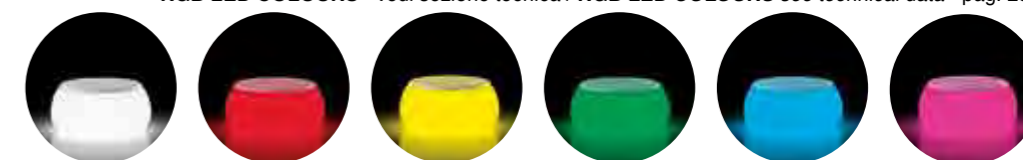

Tavolino luminoso completo di piano in PE disponibile in svariati colori. Nasce abbinato alla famiglia "Gumball", ma la sua forma pulita e armoniosa lo rende versatile e abbinabile anche ad altri elementi della linea PLUST Collection.

Luminous table with PE top available in different colours. Originally, it was created to be matched with the "Gumball" family; however, its clean-cut and harmonious shape makes it particularly versatile, allowing it to be combined with any other element of the PLUST Collection.

* **Solo per indoor.** Piano in polietilene + schiuma poliuretanic. Si consiglia l'uso indoor. In ambiente outdoor non esporre direttamente alla luce solare.

* **Only indoor.** Polyethylene top + polyurethane foam. We recommend indoor use. In the outdoor environment avoid directly solar light exposure.

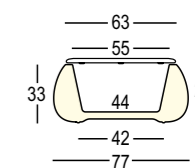

STRUCTURE

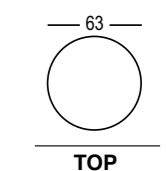

TOP

INDOOR / OUTDOOR

Art. 8248 | T BALL LIGHT INDOOR

Rigido / Hard

Predisposto per / Intended for
INDOOR-OUTDOOR Light Kit

INDOOR / OUTDOOR

COLORI BASE / BASIC COLOURS

Struttura + Piano / Structure + Top

L9

Q2

* Solo INDOOR / Only INDOOR

M1

Q6

Q7

AIRBALL ARMCHAIR LIGHT

DESIGN
ALBERTO BROGLIATO
2013



RGB LED COLOURS - vedi sezione tecnica / RGB LED COLOURS see technical data - pag. 282

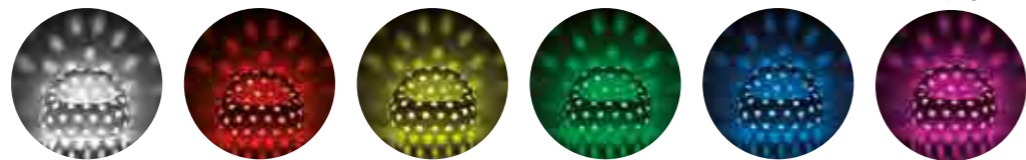

Poltroncina luminosa derivati dalla famiglia Gumball. I fori presenti sulla superficie della seduta realizzata in materiale opaco, creano scenografici giochi di luce grazie alla fonte luminosa inserita all'interno. È possibile equipaggiarla con un kit luce RGB per creare allestimenti scenografici e mutevoli.

The luminous armchair of the Gumball family. The openings on the opaque fabric seat create spectacular light effects, thanks to the light source inside. It can be equipped with an RGB lighting kit to create a stunning colour-changing display.

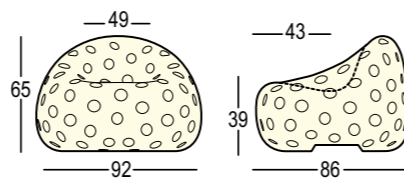

INDOOR / OUTDOOR

Art. 6284 | AIRBALL ARMCHAIR LIGHT

Rigido / Hard

Predisposto per / Intended for
INDOOR-OUTDOOR Light Kit

INDOOR / OUTDOOR

COLORI BASE / BASIC COLOURS

C2

AIRBALL SOFA LIGHT

DESIGN
ALBERTO BROGLIATO
2013



RGB LED COLOURS - vedi sezione tecnica / RGB LED COLOURS see technical data - pag. 282

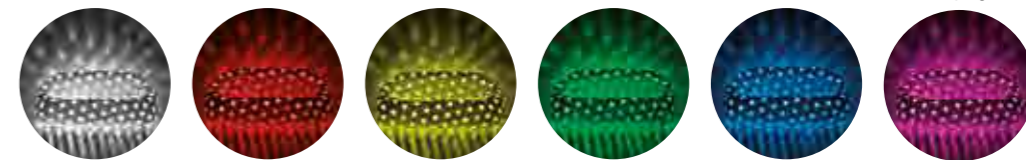

Sofa a 3 posti luminoso, caratterizzato dalla superficie forata realizzata in materiale opaco, da abbinare alla poltrona per creare scenografiche aree relax. È possibile utilizzare un kit luce RGB che grazie alla gamma colori variabile, permette di ottenere effetti cromatici dal forte impatto emozionale.

A luminous 3-seater sofa with a perforated opaque surface. Paired with the armchair, it creates an eye-catching relaxation area. It can be equipped with an RGB lighting kit, which, thanks to its vast range of colours, creates light effects of strong emotional impact.

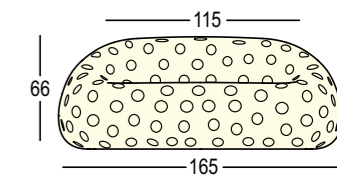

INDOOR / OUTDOOR

Art. 6283 | AIRBALL SOFA LIGHT

Rigido / Hard

Predisposto per / Intended for
INDOOR-OUTDOOR Light Kit

INDOOR / OUTDOOR

COLORI BASE / BASIC COLOURS

C2

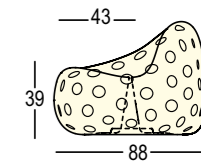



HARBO LIGHT

DESIGN
GENTLE GIANTS
2012



Vaso luminoso dalle dimensioni particolarmente imponenti ideale per ricreare dei punti luce di forte impatto visivo. Particolarmente adatto a spazi ampi e ariosi. Necessita di base di stabilizzazione o stabilizzazione e fissaggio - vedi sezione tecnica pag. 278.

Luminous vase of particularly imposing size, ideal to create points of light with a strong visual impact. Particularly suitable for spacious and airy environments. Needs a stability base or a stability and ground fixing base - see technical data pag. 278.

INDOOR / OUTDOOR

Art. 8269 | HARBO LIGHT INDOOR

Predisposto per Kit Luce INTERNI /
Intended for INDOOR Light Kit

Art. 9269 | HARBO LIGHT OUTDOOR

Predisposto per Kit Luce ESTERNI /
Intended for OUTDOOR Light Kit

INDOOR / OUTDOOR

COLORI BASE / BASIC COLOURS

98

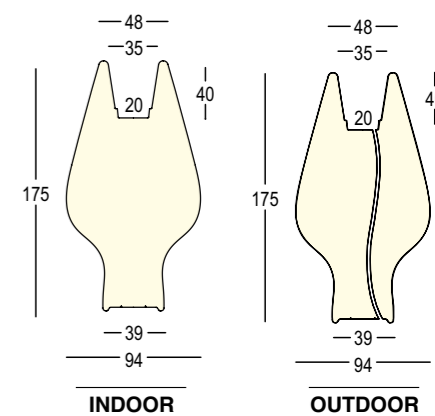



HORN LIGHT

DESIGN
ALBERTO BROGLIATO
2008



RGB LED COLOURS - vedi sezione tecnica / RGB LED COLOURS see technical data - pag. 282

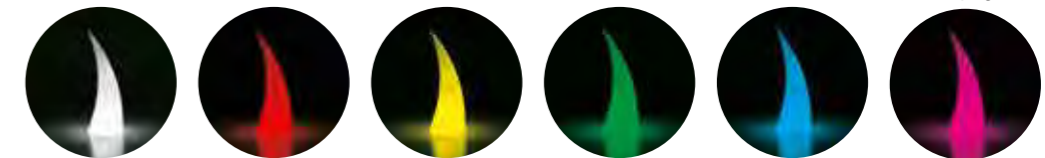

Scultura luminosa, completamente chiusa, che dalla tradizione popolare mediterranea, riedita un "cornetto portafortuna" fuoriscalda. Si integra quindi particolarmente bene in spazi dal gusto etnico e contemporaneo.

Light sculpture, completely closed, which from Mediterranean popular tradition reissued an overrange "croissant-luck-charm". It integrates especially well in space then flavor ethnic and contemporary.

INDOOR / OUTDOOR

Art. 8234 | HORN LIGHT
Predisposto per / Intended for
INDOOR-OUTDOOR Light Kit

INDOOR / OUTDOOR

COLORI BASE / BASIC COLOURS
98

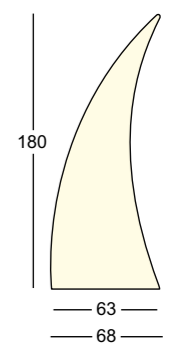



HUMPREY LIGHT

DESIGN
JOEVELLUTO (J.V.L.T.)
2007



RGB LED COLOURS - vedi sezione tecnica / RGB LED COLOURS see technical data - pag. 282

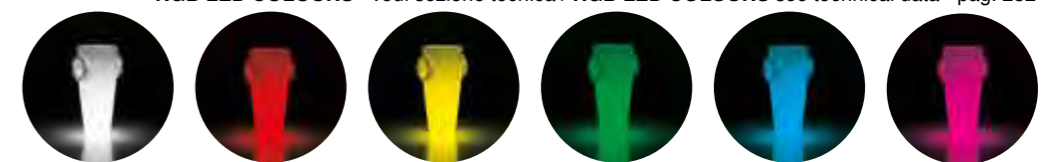

Anfora luminosa rivisitata in chiave stilizzata che si rende particolarmente adatta a contesti contract dal gusto sia classico che contemporaneo, ma ben integrabile anche come elemento singolo all'interno di uno spazio domestico. Accostando più "Humprey Light" fra loro, è possibile formare un separè luminoso inedito e di grande effetto. Disponibile base di stabilizzazione o stabilizzazione e fissaggio - vedi sezione tecnica pag. 278.

Light amphora revisited in stylized contexts is particularly suitable for contract use of both classical and contemporary flavors, but also well integrated as a single element within a domestic space. Several "Humprey Light" combined together, can form a bright and impressive divider. Available a stability base or a stability and ground fixing base - see technical data pag. 278.

INDOOR / OUTDOOR

Art. 8226
HUMPREY LIGHT INDOOR
Predisposto per Kit Luce INTERNI /
Intended for INDOOR Light Kit

Art. 9226
HUMPREY LIGHT OUTDOOR

Predisposto per Kit Luce ESTERNI /
Intended for OUTDOOR Light Kit

INDOOR / OUTDOOR

COLORI BASE / BASIC COLOURS

98

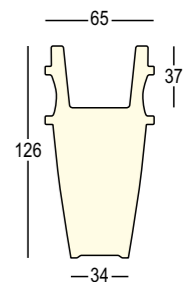

INDOOR

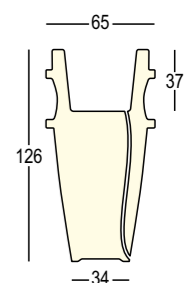

OUTDOOR



ICE-CAP LIGHT

DESIGN
LAUDANI & ROMANELLI
2009

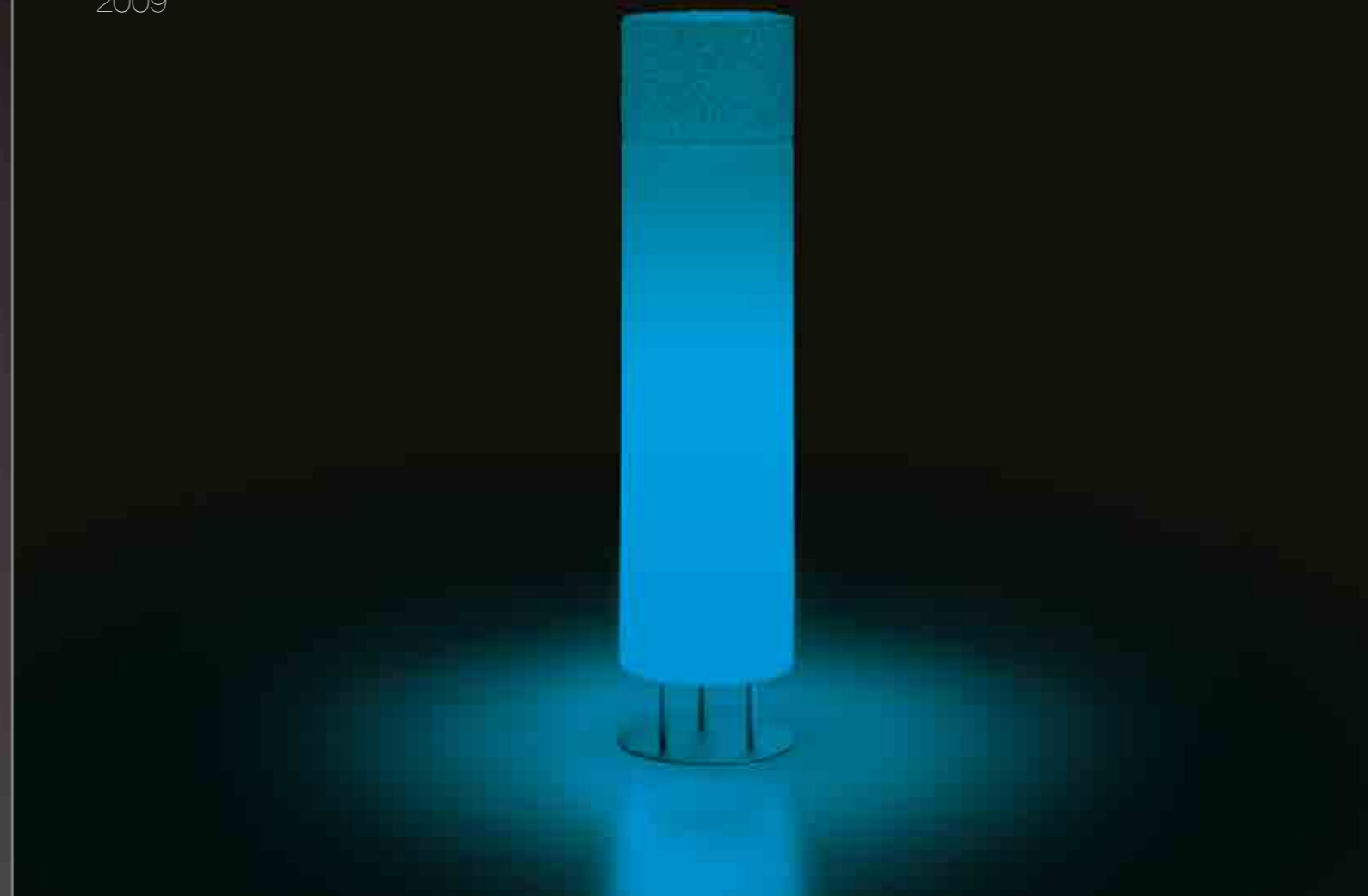

RGB LED COLOURS - vedi sezione tecnica / RGB LED COLOURS see technical data - pag. 282

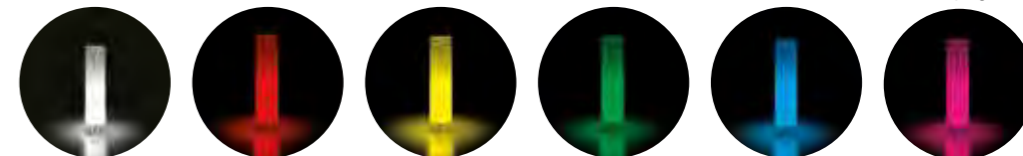

Piantana composta da un diffusore in polietilene texturizzato nella parte terminale e una base in acciaio che conferisce stabilità. Diffonde una luce delicata ed è particolarmente adatta all'illuminazione di viali e giardini per l'esterno, corridoi o zone di passaggio all'interno.

Floor lamp made of a textured polyethylene diffuser at the end and a steel base that provides stability. Diffuses a soft light and is particularly suitable for illuminating paths and gardens for the exterior, corridors or passageways inside.

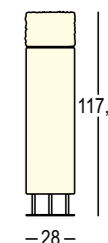

INDOOR / OUTDOOR

Art. 8243 | ICE-CAP LIGHT

Predisposto per / Intended for
INDOOR-OUTDOOR Light Kit

INDOOR / OUTDOOR

COLORI BASE / BASIC COLOURS

98



JETLAG LIGHT FAMILY

DESIGN
CÉDRIC RAGOT



JETLAG LIGHT

DESIGN
CÉDRIC RAGOT
2014



RGB LED COLOURS - vedi sezione tecnica / RGB LED COLOURS see technical data - pag. 282

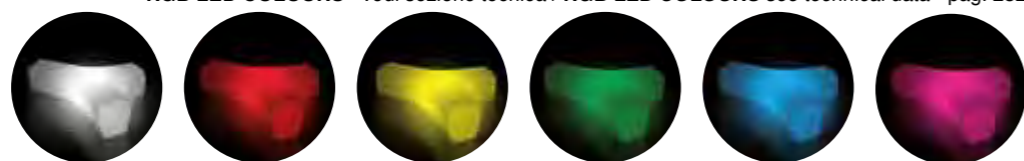

Panca modulare luminosa che assume colorazioni diverse grazie ai kit luce bianchi o a LED colorati.
A luminous modular bench that changes colour thanks to the white or coloured LED kit.

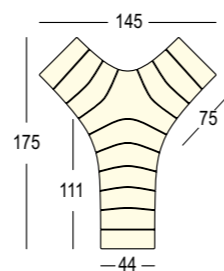
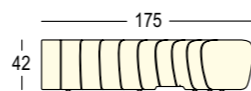

INDOOR / OUTDOOR

Art. 8291 | JETLAG LIGHT

Predisposto per / Intended for
INDOOR-OUTDOOR Light Kit

INDOOR / OUTDOOR

COLORI BASE / BASIC COLOURS

98

JETLAG CHAIR LIGHT

DESIGN
CÉDRIC RAGOT
2014



RGB LED COLOURS - vedi sezione tecnica / RGB LED COLOURS see technical data - pag. 282

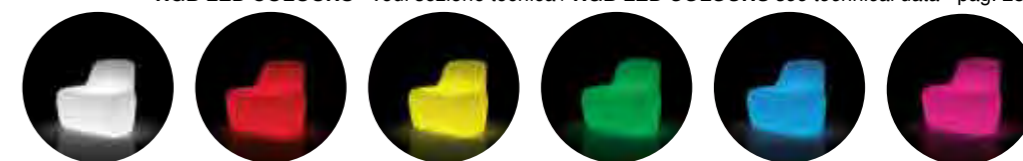

Seduta modulare luminosa che assume colorazioni diverse grazie ai kit luce bianchi o a LED colorati.
Disponibile su richiesta il sistema di fissaggio a terra (vedi sezione tecnica).

A luminous modular armchair that changes colour thanks to the white or coloured LED kit. Floor anchor system
available upon request (see technical data section).

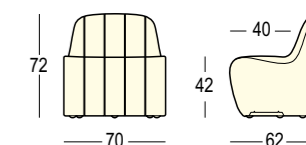

INDOOR / OUTDOOR

Art. 8293 | JETLAG CHAIR LIGHT

Predisposto per / Intended for
INDOOR-OUTDOOR Light Kit

INDOOR / OUTDOOR

COLORI BASE / BASIC COLOURS

98



NICOLE LIGHT

DESIGN
ILARIA MARELLI
2007



RGB LED COLOURS - vedi sezione tecnica / RGB LED COLOURS see technical data - pag. 282

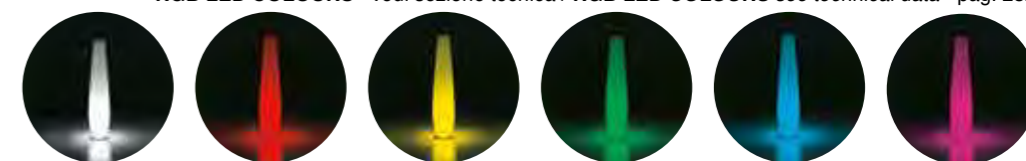

Vaso luminoso con base in acciaio inox spazzolato. La sua forma filante e slanciata lo rende particolarmente adattabile a qualsiasi contesto indoor e outdoor, sia classico che moderno. Accattivante l'impatto di svariati "Nicole" posizionati in fila su viali di giardini e corridoi.
Necessita di base di stabilizzazione o stabilizzazione e fissaggio - vedi sezione tecnica pag. 278.

*Luminous vase with polished stainless steel base. The racy and slender lines of this vase make it particularly suitable for any classical or modern, indoor or outdoor context. The impact of "Nicole" vases positioned in rows on garden walks and in corridors is quite attractive.
Needs a stability base or a stability and ground fixing base - see technical data pag. 278.*

INDOOR / OUTDOOR

Art. 8208 | NICOLE LIGHT

Predisposto per / Intended for
INDOOR-OUTDOOR Light Kit

INDOOR / OUTDOOR

COLORI BASE / BASIC COLOURS

74 

86 

98 

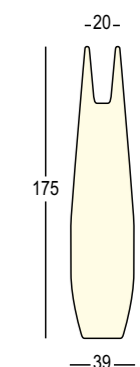

OHLA FAMILY LIGHT

DESIGN
ALBERTO BROGLIATO

VANILLA
HOTEL



OHLA ARMCHAIR LIGHT

DESIGN
ALBERTO BROGLIATO
2015



RGB LED COLOURS - vedi sezione tecnica / RGB LED COLOURS see technical data - pag. 282

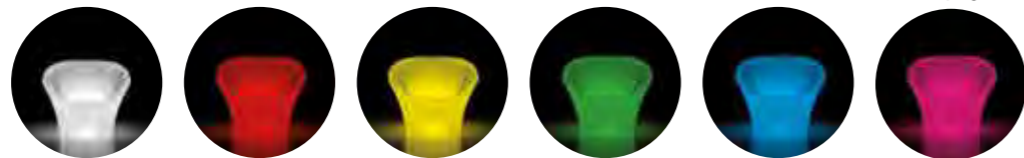

Poltrona luminosa dalla linea essenziale fortemente caratterizzante. È la perfetta sintesi tra forma e funzionalità per arredare spazi con eleganza di proporzioni e design contemporaneo.

A luminous armchair with an essential yet distinctive design. It is the perfect combination of form and function to add an elegant and contemporary touch.

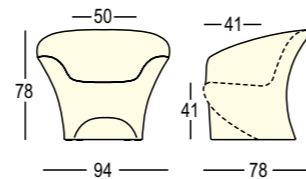

INDOOR / OUTDOOR

Art. 8238 | OHLA ARMCHAIR LIGHT

Predisposto per / Intended for
INDOOR-OUTDOOR Light Kit

INDOOR / OUTDOOR

COLORI BASE / BASIC COLOURS

98

OHLA SOFA LIGHT

DESIGN
ALBERTO BROGLIATO
2015



RGB LED COLOURS - vedi sezione tecnica / RGB LED COLOURS see technical data - pag. 282

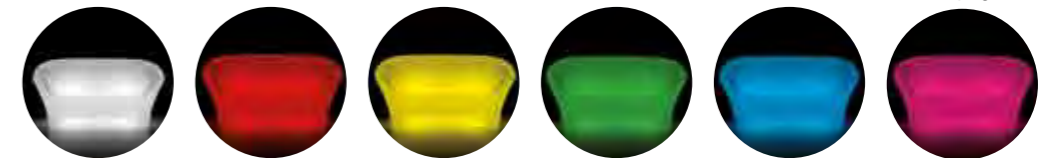

Comodo sofà luminoso a 3 posti che integra la famiglia "Ohla" per creare eleganti aree relax. Munito di 2 kit luce, arreda gli spazi con forte personalità.

A comfortable, luminous 3-seater sofa, which integrates the Ohla family to create elegant relaxation areas. Equipped with 2 light kits, it adds character to the spaces it furnishes.

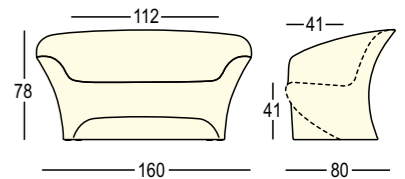

INDOOR / OUTDOOR

Art. 8304 | OHLA SOFA LIGHT

Predisposto per / Intended for
INDOOR-OUTDOOR Light Kit

INDOOR / OUTDOOR

COLORI BASE / BASIC COLOURS

98

REBELOT LIGHT FAMILY

DESIGN
MATTEO RAGNI



MINI REBELOT LIGHT



DESIGN
MATTEO RAGNI
2007

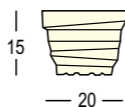

Piccola abat-jour dotata di fonte luminosa a LED bianchi, da utilizzare anche come svuotatasche o luce di cortesia.

Small abat-jour with a white LED light kit, suitable also as pocket emptier or mood light.



INDOOR	INDOOR
Art. 8548 MINI REBELOT LIGHT Completo di Kit Mini LED / With Mini LED Kit	COLORI BASE / BASIC COLOURS
	86 
	98 

REBELOT LIGHT

DESIGN
MATTEO RAGNI
2007



RGB LED COLOURS - vedi sezione tecnica / RGB LED COLOURS see technical data - pag. 282

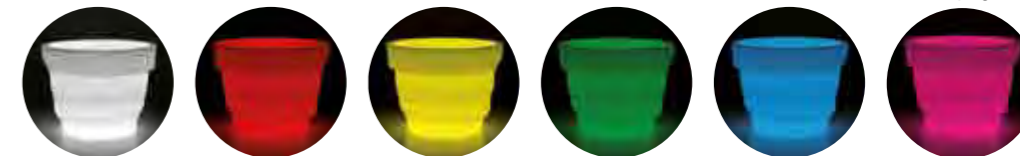

Vaso luminoso di grandi dimensioni adatto ad allestimenti d'effetto o in giardino. I piani spezzati contribuiscono a creare dei forti contrasti di luce ed ombra per una luce d'atmosfera dinamica e coinvolgente.

Big size light pot suitable for garden or effect settings. Broken plans help create strong contrasts of light and shadow, for a dynamic light in an engaging atmosphere.

INDOOR / OUTDOOR	INDOOR / OUTDOOR
Art. 8224 REBELOT LIGHT INDOOR Predisposto per Kit Luce INTERNI / Intended for INDOOR Light Kit	COLORI BASE / BASIC COLOURS
	98 

Art. 9224 | REBELOT LIGHT OUTDOOR
Predisposto per Kit Luce ESTERNI /
Intended for OUTDOOR Light Kit

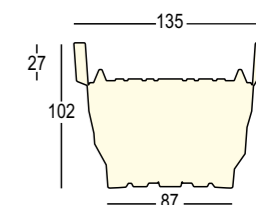

INDOOR

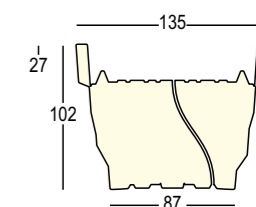

OUTDOOR



ROAMING LIGHT

DESIGN
ALBERTO BROGLIATO
2012

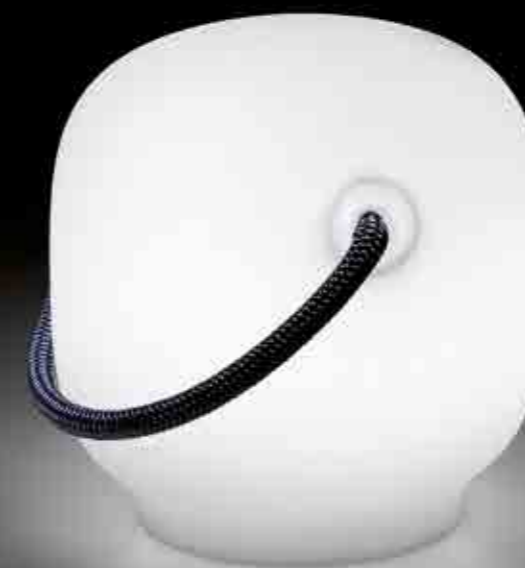

RGB LED COLOURS - vedi sezione tecnica / RGB LED COLOURS see technical data - pag. 282

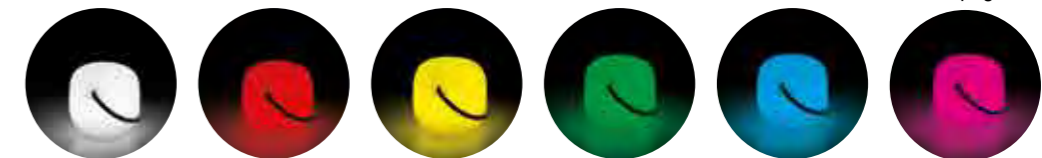

Lampada portatile con luce LED RGB alimentata da una batteria interna. Le dimensioni contenute e la corda colorata che funge da maniglia per il trasporto, configurano "Roaming" come una sorta di lanterna ricaricabile, facile da spostare per portare una luce d'atmosfera in ogni situazione. Disponibile anche con base di ricarica munita di pannello fotovoltaico. Completo di Kit luce.

Portable lamp with RGB LED light with an internal battery. The small dimensions and coloured cord of this lamp, which acts as a handle for transportation, make "Roaming" a sort of rechargeable lantern, easy to move and place in the context of an environment. Available also with a photovoltaic charger. With Light Kit.

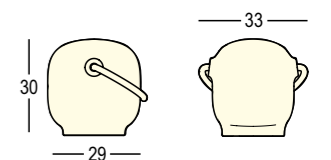

INDOOR / OUTDOOR

Art. 8275 | ROAMING LIGHT

Completo di Kit Luce ESTERNI /
With OUTDOOR Light Kit

INDOOR / OUTDOOR

COLORI BASE / BASIC COLOURS

98



ROO LIGHT

DESIGN
MONICA GRAFFEO
2008



RGB LED COLOURS - vedi sezione tecnica / RGB LED COLOURS see technical data - pag. 282

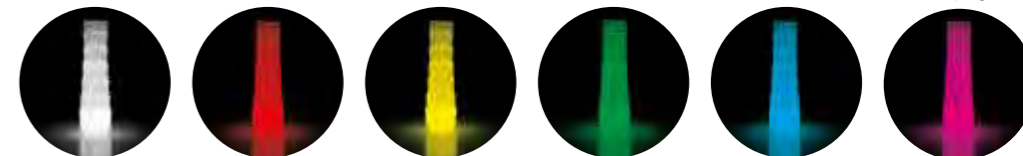

Vaso luminoso dalla superficie sinuosa che contribuisce a creare morbidi effetti di chiaroscuro. Genera una luce soffusa e accogliente, adatta per creare atmosfera anche in ogni sorta di ambiente domestico. Disponibile base di stabilizzazione o stabilizzazione e fissaggio - vedi sezione tecnica pag. 278.

Bright jar of sinuous surface that helps create soft light-and-dark effects. Creates a soft warm light, ideal for creating a special atmosphere in every kind of domestic environment.
Available a stability base or a stability and ground fixing base - see technical data pag. 278.

INDOOR / OUTDOOR

Art. 8235 | ROO LIGHT INDOOR

Predisposto per Kit Luce INTERNI /
Intended for INDOOR Light Kit

Art. 9235 | ROO LIGHT OUTDOOR

Predisposto per Kit Luce ESTERNI /
Intended for OUTDOOR Light Kit

INDOOR / OUTDOOR

COLORI BASE / BASIC COLOURS

98

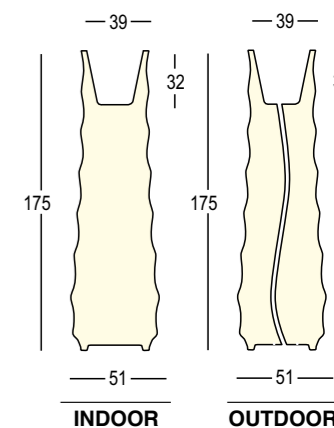



SAVING/ SPACE/ VASE LIGHT

DESIGN
JOEVELLUTO (J.V.L.T.)
2009

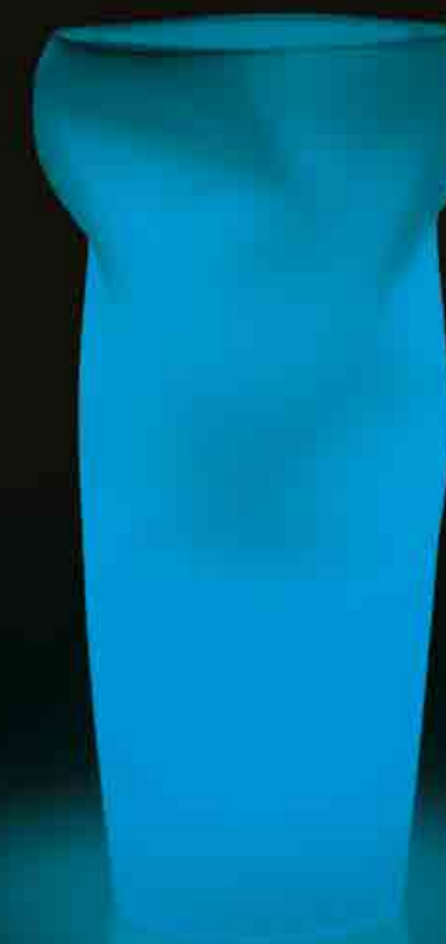

RGB LED COLOURS - vedi sezione tecnica / RGB LED COLOURS see technical data - pag. 282



Vaso luminoso dalle forme fluide ricavate dalla compressione dell'oggetto appena estratto dallo stampo, quando il materiale è ancora flessibile. La fluidità delle forme impreviste che ne risultano, contribuiscono a diffondere una luce d'atmosfera morbida e sempre diversa per ciascuna lampada, unica ma seriale. Disponibile base di stabilizzazione o stabilizzazione e fissaggio - vedi sezione tecnica pag. 278.

Bright jar of fluid forms obtained by compression of the recently extracted from the mould when the material is still flexible. The fluidity of result of unexpected shapes, help spread a soft light atmosphere which is different for each lamp, unique but serial. Available a stability base or a stability and ground fixing base - see technical data pag. 278.

INDOOR / OUTDOOR

Art. 8247
**SAVING/SPACE/VASE
LIGHT INDOOR**

Predisposto per Kit Luce INTERNI /
Intended for INDOOR Light Kit

Art. 9247
**SAVING/SPACE/VASE
LIGHT OUTDOOR**

Predisposto per Kit Luce ESTERNI /
Intended for OUTDOOR Light Kit

INDOOR / OUTDOOR

COLORI BASE / BASIC COLOURS

98

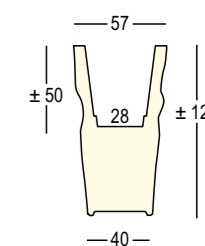

INDOOR

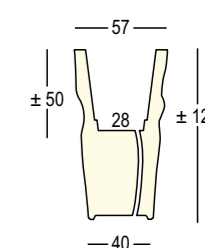

OUTDOOR



SPOT LIGHT

DESIGN
EDDY ANTONELLO
2012



Lampada per esterni da utilizzare come sospensione o a terra, per avere luce diretta o indiretta. È munita di un cavo in neoprene utile al trasporto e alla sospensione, ed un cavo elettrico per l'alimentazione.

Outdoor lamp to use suspended or set on the ground, to have direct or indirect lighting. The lamp is supplied with an electric neoprene cable for transportation and hanging, and an electric power cable.

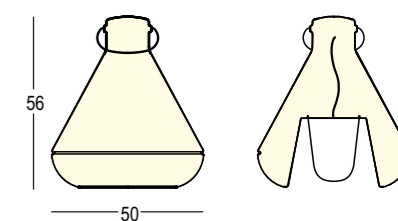

INDOOR / OUTDOOR

COLORI BASE / BASIC COLOURS
COLORATI COPRENTI / OPAQUE COLOURS

Art. 8274 | **SPOT LIGHT**

Completo di Kit Luce ESTERNI /
Intended for **OUTDOOR** Light Kit

LACCATI / LACQUERED

Art. 6574 | **SPOT LIGHT**

Completo di Kit Luce ESTERNI /
Intended for **OUTDOOR** Light Kit

INDOOR / OUTDOOR

COLORI BASE / BASIC COLOURS

COLORATI COPRENTI / OPAQUE COLOURS

- A9
- L4
- M9
- 43
- 70
- 87

INDOOR / OUTDOOR

LACCATI / LACQUERED

03



TRIM LIGHT

DESIGN
VALERIO SOMMELLA
2010



Rievocando iconograficamente la forma di un albero, "Trim" si propone come un'imponente figura totemica ideale per allestimenti suggestivi e versatile in diverse situazioni di utilizzo in indoor e outdoor. Necessita di base di stabilizzazione o stabilizzazione e fissaggio - vedi sezione tecnica pag. 278.

Iconographically recalling the shape of a tree, "Trim" is proposed as a striking totemic figure ideal for exhibitions and versatile in different situations of indoor or outdoor use. Need a stability base or a stability and ground fixing base - see technical data pag. 278.

* **Solo per outdoor.** Qualora il Kit Luce sia assemblato sul manufatto plastico assumerà il grado IP44 /
* **For outdoor use only.** Lighting kits mounted on plastic artefacts are IP44 rated

INDOOR / OUTDOOR

Art. 8253 | TRIM LIGHT
Predisposto per / Intended for
INDOOR-OUTDOOR Light Kit

INDOOR / OUTDOOR

COLORI BASE / BASIC COLOURS

74 

86 

98 

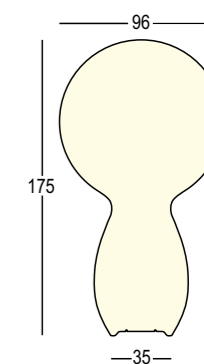



DATI TECNICI / TECHNICAL DATA

- FINITURE / FINISHINGS

- MANUTENZIONE / MAINTENANCE

- BASE ELEMENTS

- KIT LUCE / LIGHT KIT



COLORE BASE / BASIC COLORS



A2 Verde A2
Green A2

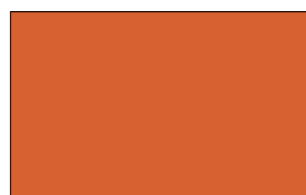

A5 Arancio A5
Orange A5



A6 Giallo A6
Yellow A6



A9 Rosso A9
Red A9



B1 Azzurro B1
Sky blue B1



B2 Rosa
Pink



B3 Giallo
Yellow



B7 Verde B7
Green B7



C1 Arancio C1
Orange C1



C2 Bianco C2
White C2



C7 Grigio C7
Grey C7



C9 Giallo curry
Curry yellow



D5 Rosa antico
Ancient rose



F1 Marrone I Was
Brown I Was



G9 Tortora
Tortora



L4 Rosmarino
Rosemary



M9 Sabbia
Sandy



N2 Cenere
Ashen

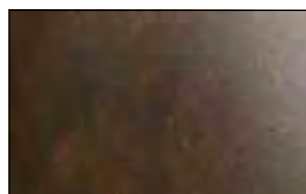

N4 Golden rust
Golden rust



Q4 Arancio Q4
Orange Q4



COLORE BASE / BASIC COLORS



08 Antracite
Anthracite grey



11 Blu
Blue



16 Blu notte
Night blue



34 Verde salvia
Sage green

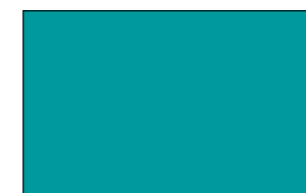

43 Verde smeraldo
Emerald green



69 Avorio
Ivory

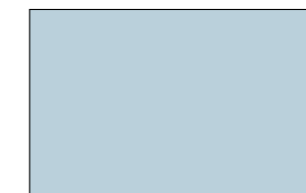

70 Azzurro
Light blue



74 Fucsia
Fuchsia

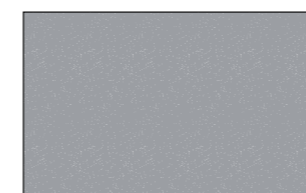

84 Grigio metal
Metal grey

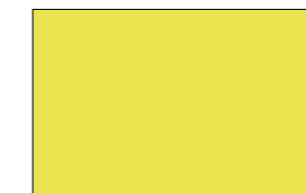

86 Verde acido
Acid green



87 Nero perla
Pearl black



88 Viola
Violet



98 Neutro
Neutral

INDOOR / OUTDOOR

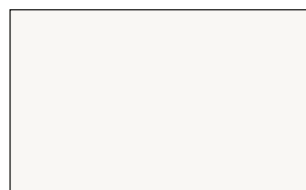
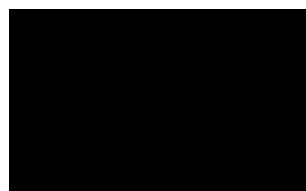
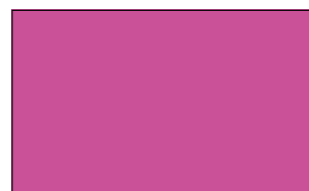

LACCATI / LACQUERED

**D3** Bianco perla
Pearl white**D7** Rosso oriente
Orient red**D8** Rosso vinaccia
Wine red**03** Bianco
White**07** Nero
Black**44** Ciclamino
Cyclamen**86** Verde acido
Acid green

METALLIZZATI / METALLIZED

**C8** Argento
Silver**E7** Oro
Gold**E8** Caffè
Coffee

EDIZIONE SPECIALE / SPECIAL EDITION

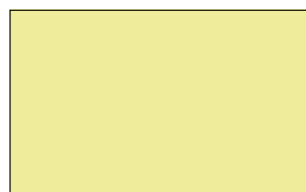
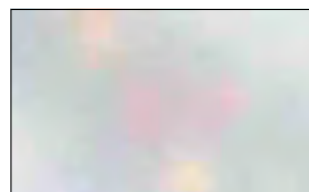
**E6** Luminescente
Photoluminescent**98** Neutro
Neutral**C0** Krome

Finiture versatili, soluzioni per interpretare e personalizzare i prodotti di PLUST Collection. Finiture pregiate, alcune realizzate solo su richiesta, che fanno dell'attenzione per i dettagli il loro punto di forza, e sono capaci di trasformare i complementi PLUST Collection in veri e propri punti di riferimento per l'arredo di un ambiente.

Versatile finishings, solutions for interpreting and customizing the PLUST Collection products.

Rich finishings, some only on demand, characterized by care and attention to details are able to transform the PLUST Collection complements in protagonists of any kind of environment.



Materiale rigenerato "I Was"
"I Was" recycled material
INDOOR / OUTDOOR



Laccato opaco
Matt lacquered
INDOOR



Foglia oro
Gold Leaf
INDOOR



Krome
INDOOR

INDOOR / OUTDOOR



FUNNY WHITE

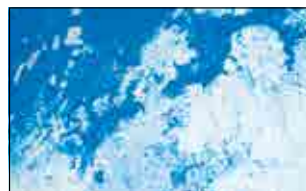

N6 Bianco - Blu
White - Blue



L7 Bianco - Arancio
White - Orange



N7 Bianco - Giallo
White - Yellow



N8 Bianco - Fucsia
White - Fuchsia



N9 Bianco - Verde smeraldo
White - Emerald green



P0 Bianco - Verde
White - Green

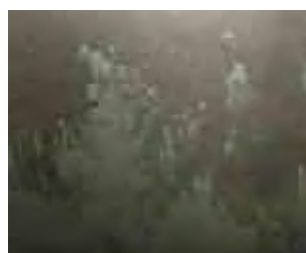

URBAN FOREST



P8 Giada - Rosmarino
Jade - Rosemary



P7 Tortora - Sabbia
Tortora - Sandy

INDOOR / OUTDOOR



INDUSTRIAL BLACK



P1 Nero - Blu
Black - Blue



P2 Nero - Arancio
Black - Orange

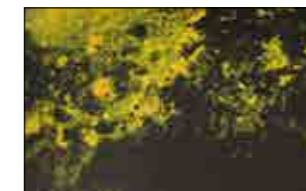

P3 Nero - Giallo
Black - Yellow



P4 Nero - Fucsia
Black - Fuchsia

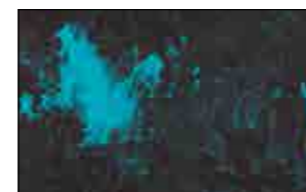

P5 Nero - Verde smeraldo
Black - Emerald green



P6 Nero - Verde
Black - Green

PIANO /
TOP



COLORI SPECIALI / SPECIAL COLOURS
PE - POLIETILENE / POLYETHYLENE
solo indoor / indoor only

*Solo per indoor: piano in polietilene + schiuma poliuretana. Si consiglia l'uso indoor. In ambiente outdoor non esporre alla luce solare.

*Only indoor: polyethylene top + polyurethane foam. We recommend indoor use. In the outdoor environment avoid directly solar light exposure.



A2 Verde
Green



B3 Giallo
Yellow



C1 Arancio
Orange



L4 Rosmarino
Rosemary



M9 Sabbia
Sandy



11 Blu
Blue

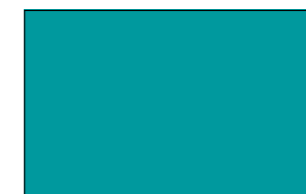

43 Verde smeraldo
Emerald green

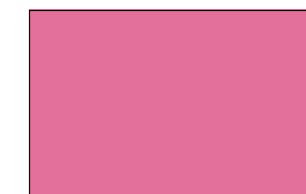

74 Fucsia
Fuchsia



**METALLO VERNICIATO OPACO /
OPAQUE VARNISHED METAL**
INDOOR / OUTDOOR



Acciaio inox
Stainless steel

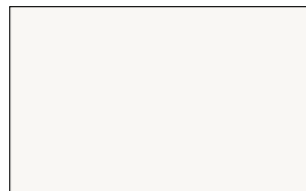

Bianco puro
Pure white



Blu pastello
Pastel blue



Verde pallido
Pale green

**PIANO /
TOP**



PE - POLIETILENE / POLYETHYLENE
INDOOR / OUTDOOR



C2 Bianco C2
White C2



69 Avorio
Ivory

PE - POLIETILENE / POLYETHYLENE
SOLO INDOOR / INDOOR ONLY

**Solo per indoor: piano in polietilene + schiuma poliuretanic. Si consiglia l'uso indoor. In ambiente outdoor non esporre alla luce solare.*

**Only indoor: polyethylene top + polyurethane foam. We recommend indoor use. In the outdoor environment avoid directly solar light exposure.*



C9 Giallo curry
Curry yellow

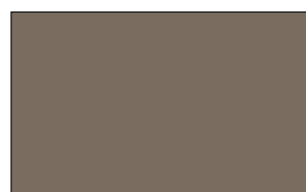

G9 Tortora
Tortora



M9 Sabbia
Sandy

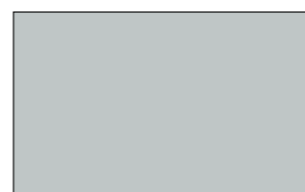

N2 Cenere
Ashen

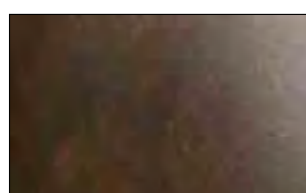

N4 Golden rust
Golden rust



74 Fucsia
Fuchsia



87 Nero perla
Pearl black



PMMA - METACRILATO / METHACRYLATE
INDOOR / OUTDOOR



Neutro
Neutral



HPL - HIGH PRESSURE LAMINATE
INDOOR / OUTDOOR

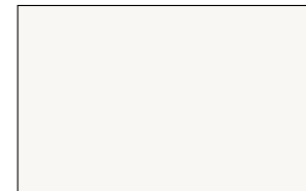

Bianco
White

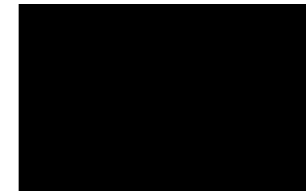

Nero
Black



LEGNO / WOOD
INDOOR / OUTDOOR

**Versione ignifuga: su richiesta
Fireproof resistant: on demand

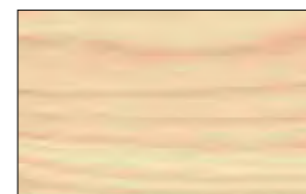

Multistrato betulla naturale
Natural birch plywood



Multistrato betulla scuro
Dark birch plywood

**Destinato all'utilizzo in ambiente esterno coperto. Non esporre alle intemperie.
Intended for use in covered outdoor environments. Do not expose to the elements.

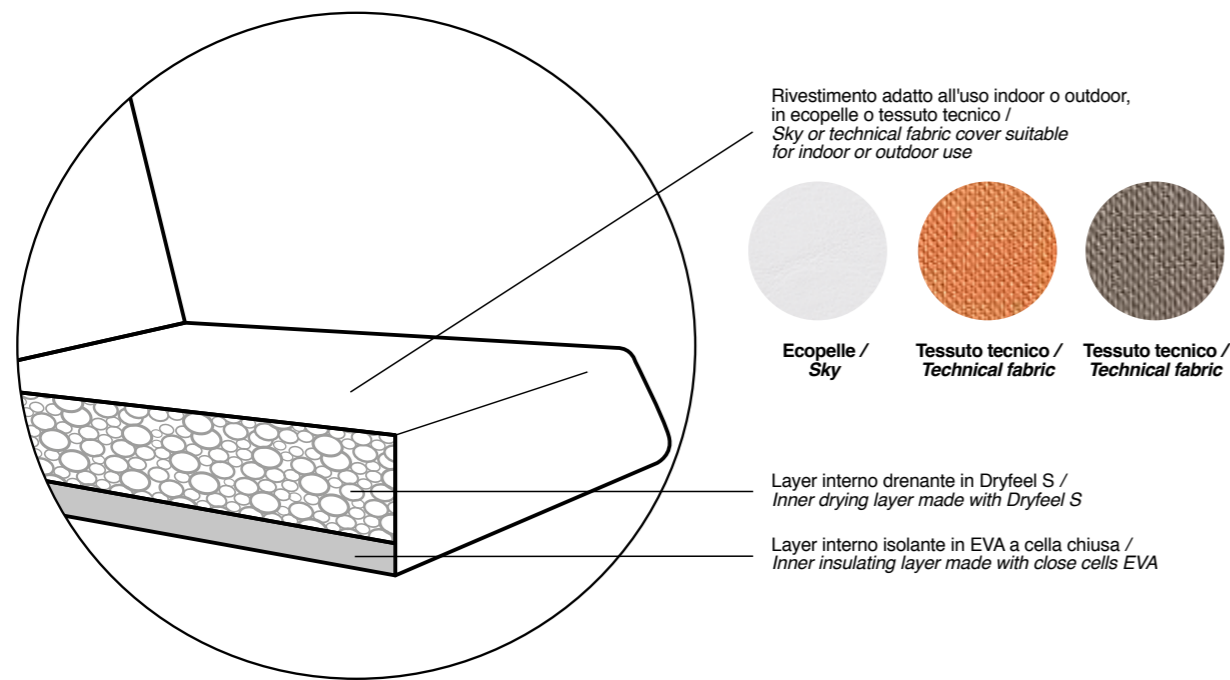

CUSCINI BIG CUT / CUSHIONS BIG CUT

INDOOR / OUTDOOR

ECOPELLE / SKY

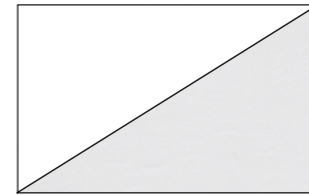
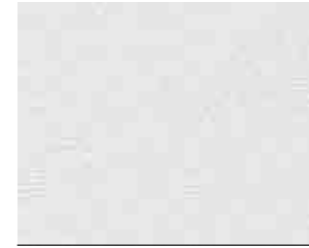

L6 Bianco-Bianco
White-White

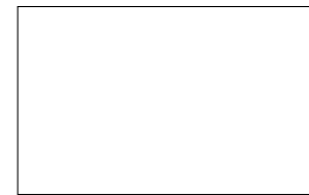

Bianco
White

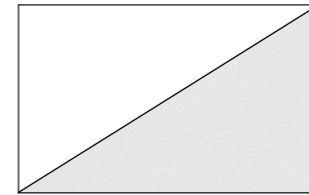

L9 Neutro-Bianco
Neutral-White

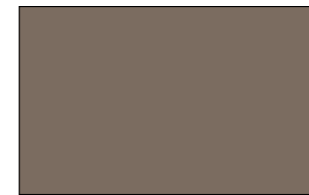

Tortora
Tortora



M6 Tortora-Bianco
Tortora-White



P9 Golden rust-Bianco
Golden rust-White

TESSUTO TECNICO / TECHNICAL FABRIC



Bianco
White

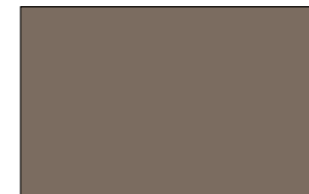

Tortora
Tortora



L7 Bianco-Arancione
White-Orange

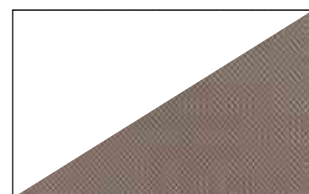

L8 Bianco-Tortora
White-Tortora

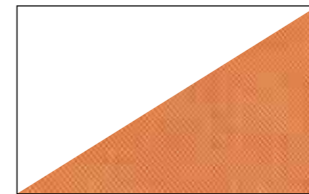

M0 Neutro-Arancione
Neutral-Orange

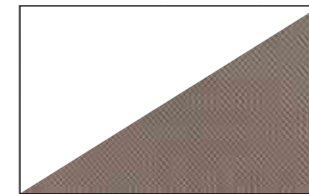

M1 Neutro-Tortora
Neutral-Tortora



M7 Tortora-Arancione
Tortora-Orange

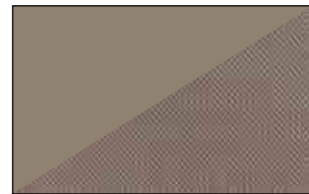

M8 Tortora-Tortora
Tortora-Tortora

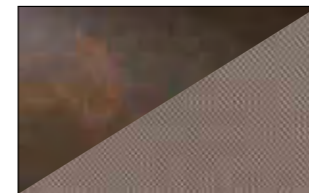

Q0 Golden rust-Tortora
Golden rust-Tortora

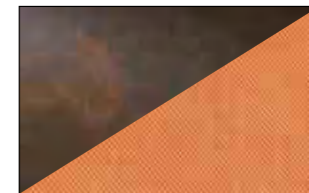

Q1 Golden rust-Arancione
Golden rust-Orange



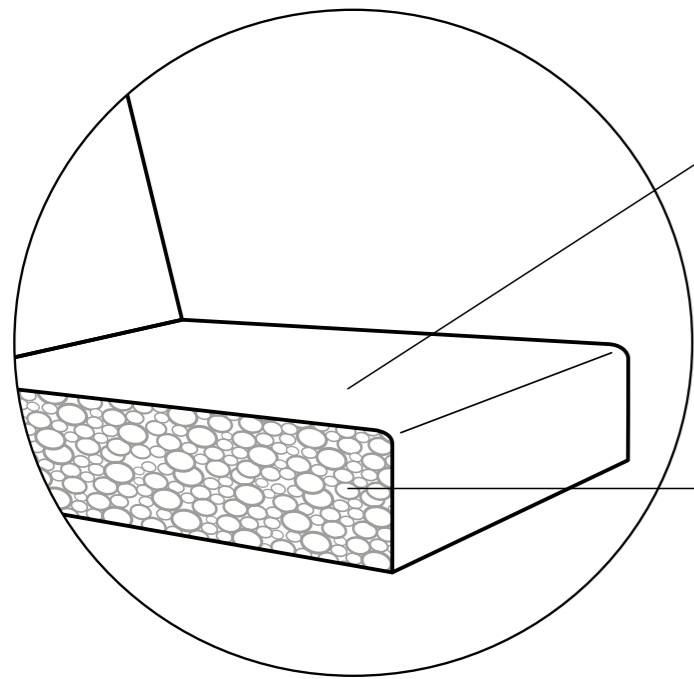

Rivestimento adatto all'uso indoor o outdoor,
in 100% acrilico Sunbrella® /
100% acrylic Sunbrella® fabric cover suitable for
indoor or outdoor use

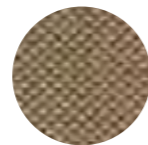

Heather Grey

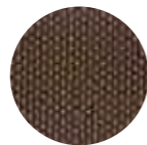

Mink Brown



White

Layer interno drenante in Dryfeel /
Inner drying layer made with Dryfeel

CUSCINI BOLD / CUSHIONS BOLD

INDOOR / OUTDOOR



SUNBRELLA®



Heather Grey



Mink Brown



White



MANUTENZIONE / MAINTENANCE

INDOOR / OUTDOOR

MANUTENZIONE /MAINTENANCE

POLIETILENE

Evitare gli accumuli di polvere e di sporco sulle superfici. Pulire periodicamente il prodotto con una spugna bagnata con acqua e detergente liquido neutro e risciacquare con una spugna e acqua. Asciugare con un panno. Si raccomanda di evitare l'utilizzo di detersivi o detergenti contenenti solventi e/o alcol etilico. In caso di sporco ostinato richiedere il detergente Euro3plast. Le versioni laccate sono adatte per uso esterno ma più sensibili ai graffi, per questo si consiglia di pulire la superficie dell'articolo delicatamente, con l'utilizzo di pasta tipo "car-polish". Per la pulizia dell'articolo e la rimozione della polvere usare un panno in microfibra bagnato, ripassare poi con un panno morbido ed asciutto. L'esposizione continua e prolungata ai raggi solari può causare l'alterazione del colore e della finitura originale dell'articolo.

LEGNO

I piani e le parti in legno degli articoli sono trattati con vernici protettive a base acqua. Gli agenti atmosferici e la luce solare sono cause naturali dell'alterazione della colorazione del legno, causandone il naturale invecchiamento. La pulizia delle superfici verniciate con prodotti all'acqua deve essere fatta con detergenti neutri (quindi non a base di acidi, ammoniaca o candeggina), non abrasivi e privi di solventi; in particolare evitare l'uso di prodotti contenuti alcol o acetone. Per proteggere il legno e mantenere viva la colorazione uniforme nel tempo e per evitare l'aggressione da parte di insetti xilofagi, pulire e trattare periodicamente il piano con prodotti per legno da esterni a base acqua, con aditivi anti UV e anti-aging, in particolar modo se il prodotto è esposto alle intemperie, seguendo le istruzioni riportate sul prodotto protettivo da voi acquistato. Destinato all'utilizzo in ambiente esterno coperto. Non esporre alle intemperie.

LAMINATO AD ALTA PRESSIONE (HPL)

I piani in laminato ad alta pressione (HPL) devono essere utilizzate con la stessa cura dedicata alle altre comuni superfici degli arredamenti da interni e esterni. È buona pratica mantenere i piani sempre puliti e rimuovere periodicamente lo sporco/polvere che si deposita sulla superficie. Per la pulizia utilizzare un panno morbido e umido con un detergente non abrasivo per la pulizia delle comuni superfici domestiche diluito in acqua. Non usare assolutamente sostante abrasive e/o spugne graffianti. Risciacquare con un panno bagnato e asciugare.

IMBOTTITI

Agli imbottiti in tessuto tecnico ed ecopelle dovrà essere riservata cura e attenzione. Pulire periodicamente la superficie con un panno umido, non abrasivo usando acqua e sapone neutro, risciacquare e lasciare asciugare bene. Non usare solventi, detergenti chimici, pulitrici a vapore. Controllare e rimuovere tempestivamente eventuale sporco quale: foglie, fiori, insetti. Lo sporco vegetale, il polline dei fiori ed il residuo di insetti, combinato all'umidità e all'acqua potrebbe creare delle macchie che penetrano nella struttura del rivestimento in ecopelle e tessuto tecnico, diventando difficili da rimuovere.

POLYETHYLENE

Avoid the build-up of dirt and dust on the surfaces. Periodically clean with a water-damped sponge and mild liquid detergent, and rinse with clean water. Dry with a cloth. Avoid using cleaners or detergents containing solvents and/or ethyl alcohol. For stubborn stains, use the special Euro3plast detergent. Lacquer versions are suitable for external use but more susceptible to scratches. We therefore recommend cleaning gently with a car-polish type of cream. To clean the product and remove the dust, use a damp microfiber cloth. Then dry with a soft dry cloth. Constant lengthy exposure to direct sun can cause alteration of the article's color and original finishing.

WOOD

The wooden surfaces and the parts of the items are treated with water-based protective varnishes/paints. Atmospheric agents and sunlight are natural causes of changes in wood tones, causing them to age naturally. Cleaning the coated surfaces with water-based products must be done using neutral non-abrasive detergents that contain no acids, ammonia, bleach or solvents; in particular, avoid using products containing alcohol or acetone. To protect the wood, keeping its color uniform over time and avoid attacks from wood-boring insects, clean and treat the surface periodically with water-based products for outdoor application on wood, with anti-UV and anti-aging additives, following the instructions of product you have purchased. ntended for use in covered outdoor environments. Do not expose to the elements.

HIGH-PRESSURE LAMINATE (HPL)

The surfaces in HPL must be used with the same care dedicated to other common surfaces of internal and external furniture. It is good practice to keep the surfaces always clean and to periodically remove dirt/dust that builds up on them. For the cleaning to use a cloth soft and umido with un Detergent not abrasive for the cleaning of the municipalities surfaces domestic iron in water. Never use abrasive substances and/or sponges that scratch. Rinse with a damp cloth and then dry.

UPHOLSTERY:

Upholstery made of technical fabric and imitation leather requires care and attention. Clean the surface periodically with a damp non-abrasive cloth using neutral soapy water; rinse and allow to fully dry. Do not use solvents, chemical detergents or steam cleaners. Check for, and remove as soon as possible, soiling such as: leaves, flowers, insects. Vegetable soiling, flower pollen and remains of insects (combined with moisture and water, they can bring stains that penetrate the imitation leather and technical fabric and prove difficult to remove. Intended for use in covered outdoor environments. Do not expose to the elements.

MANUTENZIONE / MAINTENANCE

INDOOR / OUTDOOR

MATERIALI /MATERIALS

I prodotti PLUST Collection sono realizzati con resine termoplastiche (PE), un materiale che garantisce un'incredibile resistenza agli urti, ai raggi ultravioletti e a tutte le temperature (-65°, +85°).

Tutti gli articoli della collezione, a fine vita, sono interamente riciclabili.

All PLUST Collection products are made in thermoplastic resins (PE), a material that provides excellent resistance to weather (-65° +85°), breakages and ultraviolet rays.

All PLUST Collection products are completely recyclable at end of life.

AVVERTENZE E PRECAUZIONI PER L'USO / WARNINGS AND PRECAUTIONS ON USE

Il prodotto deve essere collocato su una superficie piana. Non appoggiare oggetti lateralmente in quanto può perdere la stabilità e ribaltarsi. Non salire in piedi e utilizzare il prodotto come scala. Prestare attenzione in presenza di bambini. L'esposizione continua e prolungata ai raggi solari può causare l'alterazione della finitura originale. Il contatto con fonti di calore, stufe, caminetti, radiatori e con agenti chimici, prodotti per la pulizia diversi da quelli consigliati, possono danneggiare l'articolo. Allontanare i sacchetti in plastica appena disimballato il prodotto in quanto in presenza di bambini possono rappresentare un pericolo se utilizzati per gioco (pericolo soffocamento)

This product must placed on a level surface. Do not lean objects against the sides in case it tips over. Do not step onto the product and try to use it as steps. Take care when there are children around. Continuous and prolonged exposure to sunlight may cause changes to the original finish. Contact with sources of heat, heaters, fireplaces, radiators, chemicals and non-recommended cleaning products may damage the article. After unpacking immediately remove any plastic bags, which could be a danger to children (danger of suffocation if the child plays with it).

AVVERTENZE LUCI /WARNING LIGHTS

In caso di sostituzione della lampadina, assicurarsi che la presa di corrente sia scollegata.

Collegare la spina dell'apparecchio in una presa collocata in un luogo protetto dalla pioggia e dagli spruzzi d'acqua.

Se il cavo flessibile esterno di questo apparecchio viene danneggiato, deve essere sostituito esclusivamente dal costruttore, dal suo servizio di assistenza, o da personale qualificato equivalente, al fine di evitare pericoli.

Nelle versioni sprovviste di interruttore sul cavo di alimentazione, collegare la spina dell'apparecchio sotto una presa comandata da interruttore.

Si sconsiglia l'utilizzo e/o l'istallazione dei prodotti luminosi su superfici/pavimentazioni non solide (sabbia, terra, erba, sassi, ghiaia, ecc.).Inoltre, i prodotti luminosi non dovranno essere installati in prossimità (adiacenti e sullo stesso piano) di piscine e/o ambienti d'acqua.

Nel caso in cui il RGB LED LIGHT KIT venga smontato dal corpo lampada, evitare il contatto diretto dello sguardo con i LED accesi.

Before replacing a bulb make sure that the power plug has been disconnected

Connect the plug of the appliance to a power outlet that is located in a sheltered position, protected from rain and water splashes.

If the external flexible cable of this appliance is damaged it must be replaced by either the manufacturer, the manufacturer's customer assistance service or by equivalent qualified personnel, in order to prevent possible hazards.

For models that are not equipped with an inline on/off switch, connect the plug of the appliance to a switch controlled outlet.

The use and/or installation of illumination devices on instable surfaces/floors or pavement (sand, soil, grass, stones, gravel, etc.) is discouraged. Neither must illumination devices be installed near (adjacent to or on the same level as) swimming pools and/or other water environments

If removing the RGB LED LIGHT KIT from the lamp structure, avoid direct eye contact with the LEDs if lit up.

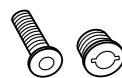
**Kit Fissaggio Base Vite Corta /
Short Screw Base Fixing Kit****Art. A4204**Kit per fissare il vaso alla base di stabilizzazione /
Device that connects a pot to a stability base**Dettagli / Details**Vite acciaio 16 x 60 mm / Steel Screw 16 x 60 mm
Inserto filettato acciaio / Threaded steel element**Adatto per / Suitable for**

Boyo	Moai 126
Buba	Moai 175
Giotto	Renè
Harbo	Roo
Humprey	Saving/Space/Vase
Max	

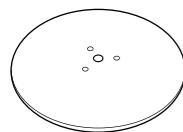
**Base di stabilizzazione /
Stability base****Art. A4184****Ø 32**Diametro 320 mm / Diameter 320 mm
Spessore 5 mm / Thickness 5 mm
Peso 3.2 kg / Weight 3.2 kg
Acciaio inox spazzolato / Brushed stainless steel**Adatto per / Suitable for**Nicole 126
Nicole 175**Art. A4196****Ø 41**Diametro 410 mm / Diameter 410 mm
Spessore 5 mm / Thickness 5 mm
Peso 5.2 kg / Weight 5.2 kg
Acciaio inox spazzolato / Brushed stainless steel**Adatto per / Suitable for**Giotto Moai 126
Max Renè**Art. A4197****Ø 51**Diametro 510 mm / Diameter 510 mm
Spessore 5 mm / Thickness 5 mm
Peso 8 kg / Weight 8 kg
Acciaio inox spazzolato / Brushed stainless steel**Adatto per / Suitable for**

Boyo	Moai 175
Buba	Roo
Harbo	Saving/Space/Vase
Humprey	

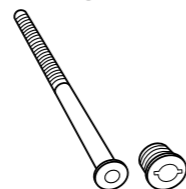
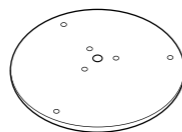
**Kit Fissaggio Base Vite Lunga /
Long Screw Base Fixing Kit****Art. A4205**Kit per fissare il vaso alla base di stabilizzazione /
Device that connects a pot to a stability base**Dettagli / Details**Vite acciaio 16 x 380 mm / Steel Screw 16 x 380 mm
Inserto filettato acciaio / Threaded steel element**Adatto per / Suitable for**Nicole 126
Nicole 175**Base di stabilizzazione e fissaggio /
Stability and ground fixing base****Art. A4195****Ø 32**Diametro 320 mm / Diameter 320 mm
Spessore 5 mm / Thickness 5 mm
Peso 3.1 kg / Weight 3.1 kg
Acciaio inox spazzolato / Brushed stainless steel
Predisposizione per il fissaggio a terra / Suitable for ground fixing**Adatto per / Suitable for**Nicole 126
Nicole 175**Art. A4193****Ø 41**Diametro 410 mm / Diameter 410 mm
Spessore 5 mm / Thickness 5 mm
Peso 5.1 kg / Weight 5.1 kg
Acciaio inox spazzolato / Brushed stainless steel
Predisposizione per il fissaggio a terra / Suitable for ground fixing**Adatto per / Suitable for**Giotto Moai 126
Max Renè**Art. A4194****Ø 51**Diametro 510 mm / Diameter 510 mm
Spessore 5 mm / Thickness 5 mm
Peso 7.9 kg / Weight 7.9 kg
Acciaio inox spazzolato / Brushed stainless steel
Predisposizione per il fissaggio a terra / Suitable for ground fixing**Adatto per / Suitable for**

Boyo	Moai 175
Buba	Roo
Harbo	Saving/Space/Vase
Humprey	

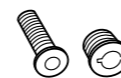
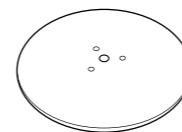
**Kit Fissaggio Base Vite Corta /
Short Screw Base Fixing Kit****Art. A4204**Kit per fissare il vaso alla base di stabilizzazione /
Device that connects a pot to a stability base**Dettagli / Details**Vite acciaio 16 x 60 mm / Steel Screw 16 x 60 mm
Inserto filettato acciaio / Threaded steel element**Adatto per / Suitable for**Baddy
Godot**Base di stabilizzazione /
Stability base****Art. A4184****Ø 32**Diametro 320 mm / Diameter 320 mm
Spessore 5 mm / Thickness 5 mm
Peso 3.2 kg / Weight 3.2 kg
Acciaio inox spazzolato / Brushed stainless steel**Adatto per / Suitable for**

Baddy

Art. A4196**Ø 41**Diametro 410 mm / Diameter 410 mm
Spessore 5 mm / Thickness 5 mm
Peso 5.2 kg / Weight 5.2 kg
Acciaio inox spazzolato / Brushed stainless steel**Adatto per / Suitable for**

Godot

Art. A4197**Ø 51**Diametro 510 mm / Diameter 510 mm
Spessore 5 mm / Thickness 5 mm
Peso 8 kg / Weight 8 kg
Acciaio inox spazzolato / Brushed stainless steel**Adatto per / Suitable for**

Godot

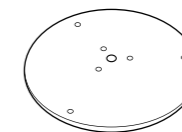
**Base di stabilizzazione e fissaggio /
Stability and ground fixing base****Art. A4195**Diametro 320 mm / Diameter 320 mm
Spessore 5 mm / Thickness 5 mm
Peso 3.1 kg / Weight 3.1 kg
Acciaio inox spazzolato / Brushed stainless steel
Predisposizione per il fissaggio a terra / Suitable for ground fixing**Adatto per / Suitable for**

Baddy

Art. A4193Diametro 410 mm / Diameter 410 mm
Spessore 5 mm / Thickness 5 mm
Peso 5.1 kg / Weight 5.1 kg
Acciaio inox spazzolato / Brushed stainless steel
Predisposizione per il fissaggio a terra / Suitable for ground fixing**Adatto per / Suitable for**

Godot

Art. A4194Diametro 510 mm / Diameter 510 mm
Spessore 5 mm / Thickness 5 mm
Peso 7.9 kg / Weight 7.9 kg
Acciaio inox spazzolato / Brushed stainless steel
Predisposizione per il fissaggio a terra / Suitable for ground fixing**Adatto per / Suitable for**

Godot

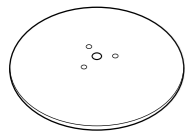
**Base di stabilizzazione /
Stability base****Art. A4184** **Ø 32**

Diametro 320 mm / *Diameter 320 mm*
Spessore 5 mm / *Thickness 5 mm*
Peso 3.2 kg / *Weight 3.2 kg*
Acciaio inox spazzolato / *Brushed stainless steel*

Adatto per / Suitable for

Nicole light

Art. A4196 **Ø 41**

Diametro 410 mm / *Diameter 410 mm*
Spessore 5 mm / *Thickness 5 mm*
Peso 5.2 kg / *Weight 5.2 kg*
Acciaio inox spazzolato / *Brushed stainless steel*

Art. A4197 **Ø 51**

Diametro 510 mm / *Diameter 510 mm*
Spessore 5 mm / *Thickness 5 mm*
Peso 8 kg / *Weight 8 kg*
Acciaio inox spazzolato / *Brushed stainless steel*

Adatto per / Suitable for

Boyo light	Humprey light
Buba light	Roo light
Frozen lamp light	Saving/Space/Vase light
Godot light	Trim light
Harbo light	

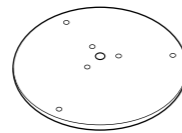
**Base di stabilizzazione e fissaggio /
Stability and ground fixing base****Art. A4195** **Ø 32**

Diametro 320 mm / *Diameter 320 mm*
Spessore 5 mm / *Thickness 5 mm*
Peso 3.1 kg / *Weight 3.1 kg*
Acciaio inox spazzolato / *Brushed stainless steel*
Predisposizione per il fissaggio a terra / *Suitable for ground fixing*

Adatto per / Suitable for

Nicole light

Art. A4193 **Ø 41**

Diametro 410 mm / *Diameter 410 mm*
Spessore 5 mm / *Thickness 5 mm*
Peso 5.1 kg / *Weight 5.1 kg*
Acciaio inox spazzolato / *Brushed stainless steel*
Predisposizione per il fissaggio a terra / *Suitable for ground fixing*

Art. A4194 **Ø 51**

Diametro 510 mm / *Diameter 510 mm*
Spessore 5 mm / *Thickness 5 mm*
Peso 7.9 kg / *Weight 7.9 kg*
Acciaio inox spazzolato / *Brushed stainless steel*
Predisposizione per il fissaggio a terra / *Suitable for ground fixing*

Adatto per / Suitable for

Boyo light	Humprey light
Buba light	Roo light
Frozen lamp light	Saving/Space/Vase light
Godot light	Trim light
Harbo light	

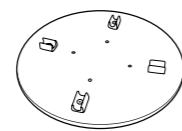
**Base di stabilizzazione e fissaggio /
Stability and ground fixing base****Art. A4594** **Ø 35**

Diametro 350 mm / *Diameter 350 mm*
Spessore 3 mm / *Thickness 3 mm*
Peso 2,6 kg / *Weight 2,6 kg*
Acciaio inox spazzolato / *Brushed stainless steel*
Predisposizione per il fissaggio a terra / *Suitable for ground fixing*

Adatto per / Suitable for

Four Lamp light

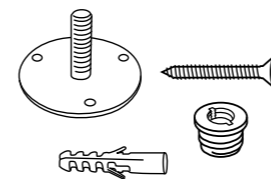
**Kit di fissaggio a terra /
Ground fixing kit****Art. A4461**

Predisposizione per il fissaggio a terra /
Suitable for ground fixing

Dettagli / Details

Base di stabilizzazione, vite autofilettante, tassello, tappo metallico /
Stabilizer base, self-tapping screw, screw anchor, metal cap

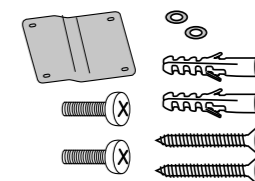
Adatto per / Suitable forBaddy
Godot**Kit di fissaggio a terra /
Ground fixing kit****Art. A4474**

Predisposizione per il fissaggio a terra Big Cut /
Suitable for ground fixing BiG Cut

Dettagli / Details

1 placchetta metallica, 2 viti M4, 2 rondelle, 2 tasselli,
2 viti autofilettanti / *1 metallic plate, 2 M4 screws,
2 washers, 2 screws anchor, 2 self-tapping screws*

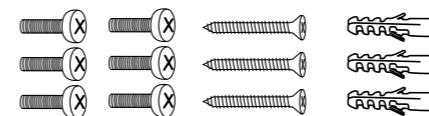
Adatto per / Suitable forBig Cut Armchair
Big Cut Corner
Big Cut Module
Big Cut Pouf
Big Cut Table**Kit di fissaggio a terra /
Ground fixing kit****Art. A4479**

Predisposizione per il fissaggio a Jetlag /
Suitable for ground fixing Jetlag

Dettagli / Details

3 staffe metalliche, 6 viti M8, 3 tasselli, 3 viti autofilettanti/
3 metallic brackets, 6 M8 screws, 3 screws anchor, 3 self-tapping screws

Adatto per / Suitable forJetlag
Jetlag Chair



E27

Lampada fluorescente MAX 1 x 60 W /
Fluorescent lamp MAX 1 x 60 W

CL. I

Classe di isolamento: Classe I.
Apparecchio protetto alla scossa elettrica tramite isolamento principale e provvisto di un dispositivo per la messa a terra.

Protection class: Class I

Apparatus protected against electric shock through main insulation, and provided with grounding device.



Classe di isolamento: Classe II.

Con doppio isolamento e/o rinforzo in ogni parte e senza dispositivi per la messa a terra /

Insulation class: Class II

With double insulation and/or reinforcement in each part and without ground devices



Classe di isolamento: Classe III

Con isolamento ridotto perchè destinato a essere esclusivamente alimentato da un sistema a bassissima tensione di sicurezza (minore o uguale a 48V DC) e nel quale si generano tensioni di valore superiore a quello di tale sistema /

Insulation class: Class III

With reduced insulation because the device is destined to be powered exclusively by a safety extra-low voltage system (max. 48V DC or less) in which voltages of values higher than those of such system are generated



Attesta la conformità del prodotto alle disposizioni delle direttive comunitarie /
It certifies the conformity of the product to the European community instructions

IP 20

Prodotto di uso ordinario. Protetto contro corpi solidi di diametro superiore a 12,5 mm. L'utente non ha comunque modo di entrare in contatto con le parti in tensione. Prodotto con nessuna protezione nei confronti della penetrazione dell'acqua /

Product for ordinary use, protected against solid objects larger than 12,5 mm in diameter. Users cannot however come into contact with the live parts. This product has no water protection

IP 44

Protetto contro corpi solidi di diametro superiore ad 1mm. Prodotto resistente agli spruzzi d'acqua /

Protected against solid bodies with a diameter over 1 mm. Splash-resistant product

IP 67

Totalmente protetto contro la penetrazione di polveri. Prodotto resistente all'immersione temporanea massimo ad 1m di profondità. L'icona, dove presente, fa riferimento al corpo lampada /

Totally protected against penetration of dust. Product resistant against temporary immersion in water to a maximum of 1 m depth. Wherever present, the icon refers to the lamp's casing

IP 68

Totalmente protetto contro la penetrazione di polveri. Prodotto resistente alla sommersione permanente in acqua. L'icona, dove presente, fa riferimento al corpo lampada /

Totally protected against penetration of dust. Product resistant against permanent immersion in water.

Wherever present, the icon refers to the lamp's casing



Ai sensi della Direttiva 2012/19/UE, il prodotto, alla fine della sua vita utile, non deve essere smaltito come rifiuto urbano /

According to the Directive 2012/19/UE, once the device life time is ended, it must not be disposed as urban waste

I kit luce A4182, A4183, A4572, A4304 e A4305 sono compatibili con lampadine di classi energetiche E → A++, e sono venduti con una lampada di classe energetica A.

I kit luce A4307, A4573, A4447 e Kit Mini LED sono muniti di lampade a LED integrate, con classe energetica A → A++ /

A4182, A4183, A4304 and A4305 Light Kit are compatible with bulbs of the energy class E → A++, and are sold with a bulb of the energy class A.

A4307, A4573, A4447 and Mini LED light kit are equipped with integrated LED bulbs of energy class A → A++

AVVERTENZE / WARNING

Si sconsiglia l'utilizzo e/o l'installazione dei prodotti luminosi su superfici/pavimentazioni non solide (sabbia, terra, erba, sassi, ghiaia, ecc.). Inoltre, i prodotti luminosi non dovranno essere installati in prossimità (adiacenti e sullo stesso piano) di piscine e/o ambienti d'acqua /

The use and/or installation of illumination devices on instable surfaces/floors or pavement (sand, soil, grass, stones, gravel, etc.) is discouraged. Neither must illumination devices be installed near (adjacent to or on the same level as) swimming pools and/or other water environments

Tutte le apparecchiature elettriche sono conformi alle direttive 2011/65/UE sulle Restrizioni d'uso di alcune sostanze pericolose (RoHS), recepite in Italia con il D. lgs 04/03/2014 n. 27 /
All electric equipments meet the Directives 2011/65/UE about the Reduction of the use of certain Hazardous Substances (RoHS), which came into force in Italy with D. lgs 04/03/2014 n. 27

AVVERTENZE / WARNING

KIT PLUST INDOOR

1. Scollegare la corrente elettrica prima di ogni operazione di assemblaggio
2. Collegare la spina dell'apparecchio in una presa collocata in un luogo protetto dalla pioggia e dagli spruzzi d'acqua
3. Se il cavo flessibile esterno di questo apparecchio viene danneggiato, deve essere sostituito esclusivamente dal costruttore, dal suo servizio di assistenza, o da personale qualificato equivalente, al fine di evitare pericoli
4. Evitare il contatto diretto dello sguardo con il MINI LED acceso
5. Accendere il MINI LED solo dopo averlo assemblato al manufatto plastico
6. Si sconsiglia l'utilizzo e/o l'installazione dei prodotti luminosi su superfici/pavimentazioni non solide (sabbia, terra, erba, sassi, ghiaia, ecc.). Inoltre, i prodotti luminosi non dovranno essere installati in prossimità (adiacenti e sullo stesso piano) di piscine e/o ambienti d'acqua /

1. Disconnect the electrical power supply before beginning assembly operations
2. Connect the plug of the appliance to a power outlet that is located in a sheltered position, protected from rain and water splashes
3. If the external flexible cable of this appliance is damaged it must be replaced by either the manufacturer, the manufacturer's customer assistance service or by equivalent qualified personnel, in order to prevent possible hazards.
4. Avoid eye-contact with the light emitted by th MINI LED
5. Do not switch on the MINI LED until it has been mounted on the plastic component
6. The use and/or installation of illumination devices on instable surfaces/floors or pavement (sand, soil, grass, stones, gravel, etc.) is discouraged. Neither must illumination devices be installed near (adjacent to or on the same level as) swimming pools and/or other water environments

KIT PLUST OUTDOOR

1. Scollegare la corrente elettrica prima di ogni operazione di assemblaggio
2. Collegare la spina dell'apparecchio in una presa collocata in un luogo protetto dalla pioggia e dagli spruzzi d'acqua
3. Se il cavo flessibile esterno di questo apparecchio viene danneggiato, deve essere sostituito esclusivamente dal costruttore, dal suo servizio di assistenza, o da personale qualificato equivalente, al fine di evitare pericoli
4. L'articolo "Four Lamp" nella versione con kit a sospensione (A4596), se utilizzato all'esterno, dovrà essere posizionato in luogo coperto.
5. Evitare il contatto diretto dello sguardo con il RGB Led Light acceso
6. Accendere RGB Led Light solo dopo averlo assemblato al manufatto plastico
7. Nelle versioni sprovviste di interruttore sul cavo di alimentazione, collegare la spina dell'apparecchio sotto una presa comandata da interruttore
8. Si sconsiglia l'utilizzo e/o l'installazione dei prodotti luminosi su superfici/pavimentazioni non solide (sabbia, terra, erba, sassi, ghiaia, ecc.). Inoltre, i prodotti luminosi non dovranno essere installati in prossimità (adiacenti e sullo stesso piano) di piscine e/o ambienti d'acqua /

1. Disconnect the electrical power supply before beginning assembly operations
2. Connect the plug of the appliance to a power outlet that is located in a sheltered position, protected from rain and water splashes
3. If the external flexible cable of this appliance is damaged it must be replaced by either the manufacturer, the manufacturer's customer assistance service or by equivalent qualified personnel, in order to prevent possible hazards
4. If used outdoors, the suspension kit version (A4596) of the article "Four Lamp" must be installed in a covered context.
5. Avoid eye-contact with the light emitted by the RGB Led Light
6. Do not switch on the RGB Led Light until it has been mounted on the plastic component
7. For models that are not equipped with an inline on/off switch, connect the plug of the appliance to a switch controlled outlet
8. The use and/or installation of illumination devices on instable surfaces/floors or pavement (sand, soil, grass, stones, gravel, etc.) is discouraged. Neither must illumination devices be installed near (adjacent to or on the same level as) swimming pools and/or other water environments

KIT LUCE RGB / RGB LIGHT KIT

INDOOR / OUTDOOR

Art. A4307

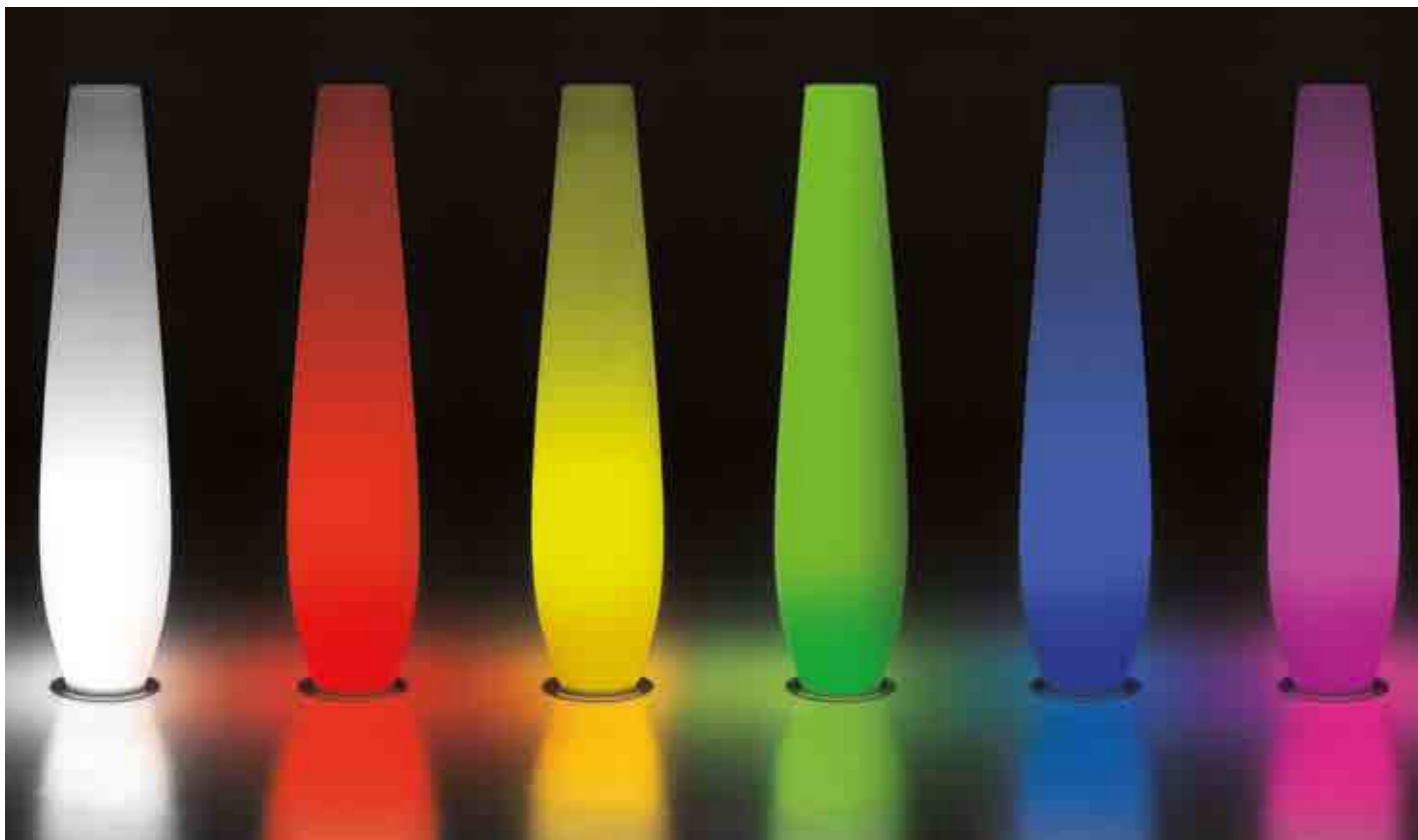

LED RGB: colori / colours

Dettagli / Details

Guscio in policarbonato / Polycarbonate shell

Guarnizione a tenuta / Gasket seal

Telecomando / Remote control

Cavo nero / Black cable

Spina europea bipolare / European bipolar plug

Trasformatore in 12V a parete / 12V wall transformer

Lunghezza cavo 500 / Wire length 500

Predisposizione per base di stabilizzazione / Arrangement for stability base

La spina di alimentazione dovrà essere inserita in una presa di rete posizionata in un luogo coperto /

The power plug must be connected to a socket that is located in a covered area

Luce / Light

Modulo 60 LED RGB 15 W / 15 W RGB LED 60 module



Il kit professionale applicabile a tutti i prodotti "Lights" di PLUST Collection utilizza la tecnologia a risparmio energetico LED RGB, attraverso la quale è possibile trasformare ogni oggetto in una scultura luminosa e colorata.

A seconda dello scenario, del contesto, o della particolare suggestione che si vuole creare, si può scegliere il colore della luce più adatto, o semplicemente lasciare che la lampada trasformi il colore lentamente in sequenza, regalando un coinvolgente spettacolo cromatico.

The professional kit, applicable to all PLUST Collection "lights", uses RGB LED technology to save energy, through which you can turn any object into a glowing colorful sculpture.

Depending on the scenario, context, or that particular suggestion to be created, you can choose the most suitable light colour, or simply let the lamp turn the color slowly in sequence, giving a fascinating show of colour.

LAMPADE COLORATE / LIGHTING COLOURS

INDOOR / OUTDOOR



Spento / Not enlightened



Acceso / Enlightened

Dettagli / Details

Materiale colorato per oggetti luminosi, disponibile per alcuni articoli "Lights" di PLUST Collection /

Coloured material for bright objects, available for some products of PLUST Collection "Lights".

Colorati / Colours

74  Fucsia
Fuchsia

86  Verde acido
Acid green

Utilizzando un particolare materiale tinto in massa che lascia filtrare i raggi luminosi dall'interno, è possibile ottenere un oggetto che diffonde luce colorata utilizzando un semplice kit luce standard.

Di giorno la lampada si presenta come una scultura colorata, mentre di notte si accende creando suggestive atmosfere.

Le due colorazioni, fucsia e verde acido, sono disponibili per alcuni articoli "Lights" di PLUST Collection.

Using a particular dyed material, it filters the light rays from the inside, you can get an object that diffuses colored light using a simple light standards kit.

By day the lamp seems a coloured sculpture, while at night it glows creating evocative moods.

The two colours, pink and acid green are available for some products of PLUST Collection "Lights".

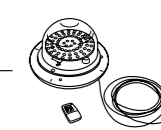
**KIT LUCE /
LIGHT KIT****KIT LUCE INTERNI /
INDOOR LIGHT KIT****Kit Luce / Light Kit - Art. A4183**
Kit Luce INTERNI / INDOOR Light Kit**Packaging:**
Cm 29 x 24 x 20 h**Dettagli / Details**Cavo trasparente / *Transparent cable*
Pulsantiera a pedale / *Foot switch*
Spina europea bipolare / *European bipolar plug*
Lunghezza cavo 370 cm / *Wire length 370 cm*
Predisposizione per base di stabilizzazione /
*Arrangement for stability base***Luce / Light** 1 x 20 W**KIT LUCE ESTERNI /
OUTDOOR LIGHT KIT****Kit Luce / Light Kit - Art. A4182**
Kit Luce ESTERNI / OUTDOOR Light Kit**Packaging:**
Cm 29 x 24 x 20 h**Dettagli / Details**Guscio in policarbonato / *Polycarbonate shell*
Guarnizione a tenuta / *Gasket seal*
Telecomando / *Remote control*
Cavo nero / *Black cable*
Spina Schuko antispruzzo / *Anti-splash Schuko plug*
Lunghezza cavo 280 cm / *Wire length 280 cm*
Predisposizione per base di stabilizzazione /
*Arrangement for stability base***Luce / Light** 1 x 20 W**KIT LUCE /
LIGHT KIT****KIT LUCE ESTERNI
OPALINO /
OPALINE OUTDOOR
LIGHT KIT****Kit Luce / Light Kit - Art. A4572**
Kit Luce ESTERNI opalino / Opaline OUTDOOR Light Kit**Packaging:**
Cm 29 x 24 x 20 h**Dettagli / Details**Guscio in policarbonato opalino / *Opaline polycarbonate shell*
Guarnizione a tenuta / *Gasket seal*
Telecomando / *Remote control*
Cavo nero / *Black cable*
Spina Schuko antispruzzo / *Anti-splash Schuko plug*
Lunghezza cavo 280 cm / *Wire length 280 cm*
Predisposizione per base di stabilizzazione /
*Arrangement for stability base***Luce / Light** 1 x 20 W**RGB LED LIGHT
KIT SENZA
TRASFORMATORE /
RGB LED LIGHT
KIT WITHOUT
TRANSFORMER****Kit Luce / Light Kit - Art. A4447**
RGB LED Light Kit**Packaging:**
Cm 28 x 23 x 21 h**Dettagli / Details**Guscio in policarbonato / *Polycarbonate shell*
Guarnizione a tenuta / *Gasket seal*
Telecomando / *Remote control*
Cavo nero / *Black cable*
Connettore a 2 poli INDOOR / *2 pole connector INDOOR*
Privo di trasformatore / *Without wall transformer*
Lunghezza cavo 490 cm / *Wire length 490 cm*
Predisposizione per base di stabilizzazione /
*Arrangement for stability base***Luce / Light**Modulo 60 LED RGB 15 W / *15 W RGB LED 60 module*

KIT LUCE / LIGHT KIT

RGB LED LIGHT KIT OPALINO / OPALINE RGB LED LIGHT KIT

Kit Luce / Light Kit - Art. A4573

RGB LED Light Kit



Packaging:

Cm 28 x 23 x 21 h

Dettagli / Details

Guscio in policarbonato opalino / *Opaline polycarbonate shell*

Guarnizione a tenuta / *Gasket seal*

Telecomando / *Remote control*

Cavo nero / *Black cable*

Spina europea bipolare / *European bipolar plug*

Trasformatore in 12V a parete / *12V wall transformer*

Lunghezza cavo 490 / *Wire length 490*

Predisposizione per base di stabilizzazione /

Arrangement for stability base

La spina di alimentazione dovrà essere inserita in una presa

di rete posizionata in un luogo coperto /

The power plug must be connected to a socket that is located

in a covered area

Luce / Light

Modulo 60 LED RGB 15 W / *15 W RGB LED 60 module*



KIT LED RGB A BATTERIA CON SPINA / RGB LED LIGHT KIT WITH BATTERY AND PLUG

Kit Luce / Light Kit - Art. A4364

Base di ricarica a spina / *Charger with plug*



Packaging:

Cm 28 x 23 x 21 h

Dettagli / Details

Kit LED RGB a batteria powered by Smart&Green /

RGB LED Kit with battery powered by Smart&Green

Autonomia 6 ore circa, alla massima intensità /

Autonomy 6 hours on average at maximum power

Luce: bianca, colorata, a rotazione /

Light: white, coloured, rotating colours

Telecomando / *Remote control*

Base di ricarica con spina europea bipolare /

Charger with european bipolar plug

Maniglia: cima nautica / *Handle: nautical rope*

Luce / Light



Adatto per / Suitable for:

Drop Light indoor/outdoor

Gumball Armchair Light

Gumball Sofa Light

(necessita di 2 Kit Luce / *needs 2 Light Kit*)

KIT LUCE / LIGHT KIT

KIT MINI LED INTERNI / OUTDOOR MINI LED KIT

Kit Luce / Light Kit - Art. A4303

Kit MINI LED INTERNI / *INDOOR MINI LED Kit*



Packaging:

Cm 29 x 24 x 20 h

Dettagli / Details

Cavo trasparente / *Transparent cable*

Spina europea bipolare / *European bipolar plug*

Trasformatore in 12V a parete / *12V wall transformer*

Pulsantiera / *Switch*

Lunghezza cavo 140 cm / *Wire length 140 cm*

Luce / Light

Modulo 6 LED bianchi 1,5 W / *1,5 W white 6 LED Module*



KIT LUCE INTERNI / INDOOR LIGHT KIT

Kit Luce / Light Kit - Art. A4304

Kit Luce INTERNI / *INDOOR Light Kit*

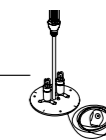

Packaging:

Cm 21 x 21 x 120 h

Dettagli / Details

Cavo trasparente / *Transparent cable*

Pulsantiera a pedale / *Foot switch*

Spina europea bipolare / *European bipolar plug*

Lunghezza cavo 250 / *Wire length 250*

Predisposizione per base di stabilizzazione /

Arrangement for stability base

Stelo h 105 cm / *Stem h 105 cm*

Luce / Light 1 x 23 W + 2 x 8 W

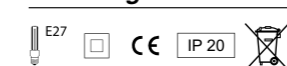

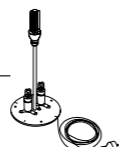
KIT LUCE ESTERNI /
OUTDOOR LIGHT KIT**Kit Luce / Light Kit - Art. A4305**
Kit Luce ESTERNI / *OUTDOOR Light Kit***Packaging:**

Cm 21 x 21 x 120 h

Dettagli / DetailsGuscio in policarbonato / *Polycarbonate shell*Guarnizione a tenuta / *Gasket seal*Cavo nero / *Black cable*Spina Schuko antispruzzo / *Anti-splash Schuko plug*Lunghezza cavo 280 / *Wire length 280*

Predisposizione per base di stabilizzazione /

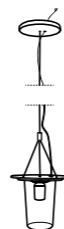
*Arrangement for stability base*Stelo h 105 cm / *Stem h 105 cm***Luce / Light** 1 x 23 W + 2 x 8 W* Solo per outdoor. Qualora il Kit Luce sia assemblato sul
manufatto plastico assumerà il grado IP44 /* *For outdoor use only. Lighting kits mounted on pla-
stic artefacts are IP44 rated*KIT LUCE A
SOSPENSIONE PER
INTERNI/ESTERNI
INDOOR/OUTDOOR
LIGHT KIT TO
SUSPENSION**Kit Luce / Light Kit - Art. A4596**Kit Luce INTERNI - ESTERNI /
INDOOR - OUTDOOR Light Kit**Packaging:**

Cm 28 x 23 x 21 h

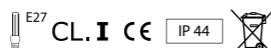
Dettagli / DetailsGuscio in policarbonato / *Polycarbonate shell*Guarnizione a tenuta / *Gasket seal*Cavo nero / *Black cable*Piastra in policarbonato / *Polycarbonate plate*Fili in acciaio per la sospensione / *Steel wires for suspension*Staffa metallica di fissaggio a soffitto / *Metal bracket for ceiling mount*Rosone metallico / *Metal ceiling rose*Lunghezza cavo 200 cm / *Wire length 200 cm*Kit luce regolabile in altezza / *Light kit adjustable in height***Luce / Light**

OVERVIEW
FURNITURE



ARMILLARIA FAMILY
Odoardo Fioravanti

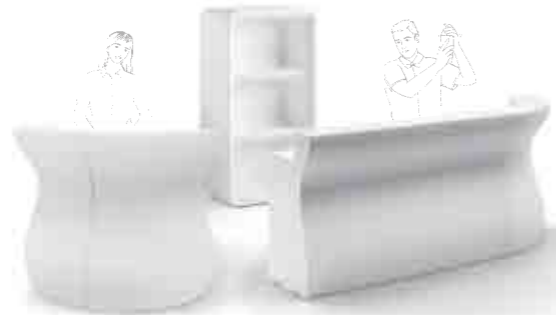

BARTOLOMEO FAMILY
JoeVelluto (JVL)

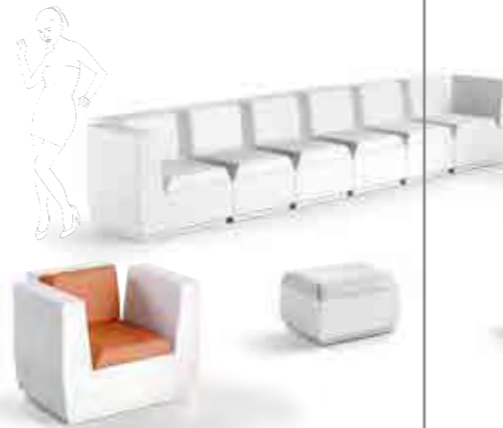

BIG CUT FAMILY
Matali Crasset



FROZEN FAMILY
Matteo Ragni + Maurizio Prina



FURA FAMILY
Form Us With Love



FUZZY STOOL
Eddy Antonello



GOEN - ENTA
Setsu & Shinobu Ito



GUMBALL FAMILY
Alberto Brogliato



GUMBALL JUNIOR FAMILY
Alberto Brogliato



AIRBALL FAMILY
Alberto Brogliato



JETLAG FAMILY
Cédric Ragot



OHLA FAMILY
Alberto Brogliato

OVERVIEW
FURNITURE



BOLD FAMILY
Giulio Iacchetti

OVERVIEW

FURNITURE



PLANET FAMILY
Cédric Ragot



PLAST VAN - MINI PLUST VAN
Michele Menescardi



SIMPLE FAMILY
JoeVelluto (JVLT) + Eddy Antonello



SAT
Marco Zito



TALEA CHAIR
Marco Zito



TALEA BENCH
Marco Zito

OVERVIEW

ACCESSORIES



BADDY - MINI BADDY
JoeVelluto (JVLT)
+ Alberto Fabbian



BIGGIE
Filippo Protasoni



DRAGO - DRAGHETTO
Alberto Ghirardello



GODOT
Alberto Brogliato



GRADIENT 160
GRADIENT 180
Mut Design

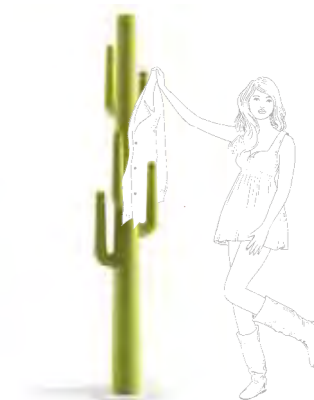

LAPSUS
Eddy Antonello
+ Alberto Fabbian



LEAF
FLOWER
Emo Design



MOON-LEAVES 1
MOON-LEAVES 2
Laudani & Romanelli

OVERVIEW

POTS



BOYO
Gentle Giants



BUBA
E3P Design Dept.



CACTUS
Giulio Iacchetti



GIOTTO - MAX - RENÈ
Miriam Mirri



HALFUL
JoeVelluto (JVLT)



HARBO
Gentle Giants



NICOLE
Ilaria Marelli

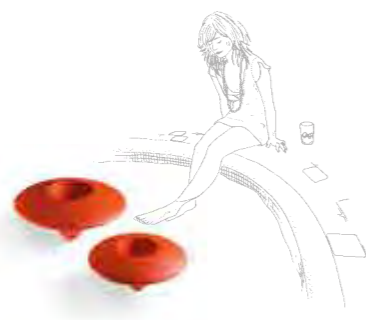

NINFEA
Alessandro Busana



RÀ
Valerio Tonel



SAVING/SPACE/VASE
JoeVelluto (JVLT)



SEPIO
Matteo Ragni



SHOCK
Alberto Brogliato



TAMBO
Luca Nichetto

OVERVIEW

POTS



CUBALIBRE
Giulio Iacchetti



DIAMOND
JoeVelluto (JVLT)



DROP
Emmanuel Babled



FUZZY POT
Eddy Antonello



HUMPREY
JoeVelluto (JVLT)



MADAME
Alessandro Busana



MOAI
Luca Nichetto



MORE
E3P Design Dept.



REBELOT
Matteo Ragni



REVERSE
Matteo Ragni



ROO
Monica Graffeo



T BALL POT
Alberto Brogliato



TONQUA
Valerio Tonel



TROTTOLA
Ilaria Marelli

OVERVIEW
LIGHTS



BADDY LIGHT
MINI BADDY LIGHT
JoeVelluto (JVL) + Alberto Fabbian



BARTOLOMEO FAMILY LIGHT
JoeVelluto (JVL)



BIGGIE LIGHT
Filippo Protasoni



BOLD FAMILY LIGHT
Giulio Iacchetti



CUBALIBRE TABLE LIGHT
Giulio Iacchetti

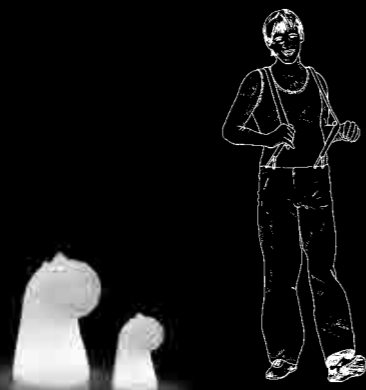

DRAGO LIGHT
DRAGHETTO LIGHT
Alberto Ghirardello



DROP LIGHT
Emmanuel Babled

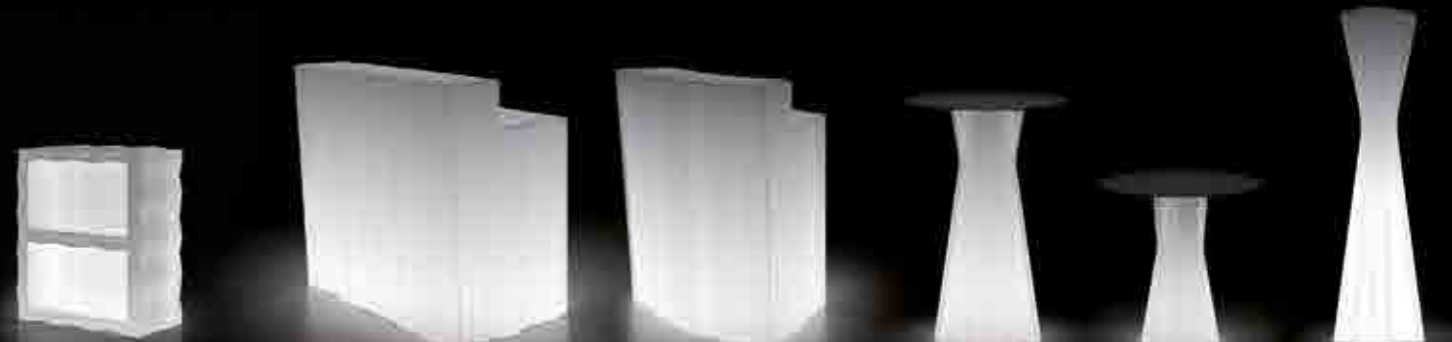

OVERVIEW
LIGHTS

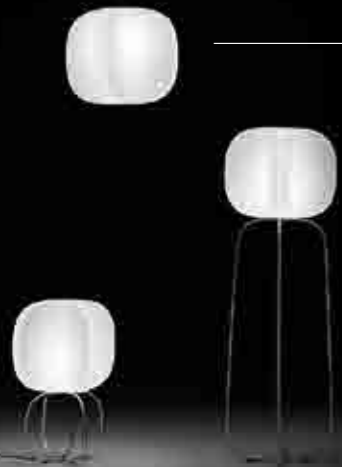

FOUR LAMP LIGHT
Philippe Tabet



FURA FAMILY LIGHT
Form Us With Love



GODOT LIGHT
Alberto Brogliato



HARBO LIGHT
Gentle Giants



HORN LIGHT
Alberto Brogliato



HUMPREY LIGHT
JoeVelluto (JVL)



ICE-CAP LIGHT
Laudani & Romanelli

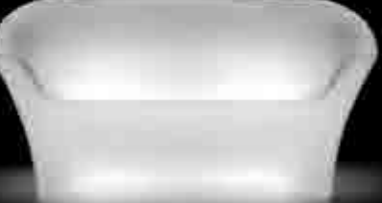

NICOLE LIGHT
Ilaria Marelli



REBELOT LIGHT
MINI REBELOT LIGHT
Matteo Ragni



ROAMING LIGHT
Alberto Brogliato





- | | | | |
|-----------------------|------------------------|-----------------------|---------------------|
| 01 Eddy Antonello | 09 Form Us With Love | 17 Ilaria Marelli | 25 Cédric Ragot |
| 02 Emmanuel Babled | 10 Alberto Ghirardello | 18 Michele Menescardi | 26 Valerio Sommella |
| 03 Alberto Brogliato | 11 Gentle Giants | 19 Miriam Mirri | 27 Philippe Tabet |
| 04 Alessandro Busana | 12 Monica Graffeo | 20 Mut Design | 28 Valerio Tonel |
| 05 Matali Crasset | 13 Giulio Iacchetti | 21 Luca Nichetto | 29 Marco Zito |
| 06 Emo Design | 14 Setsu & Shinobu Ito | 22 Maurizio Prina | |
| 07 Alberto Fabbian | 15 JoeVelluto (JVLT) | 23 Filippo Protasoni | |
| 08 Odoardo Fioravanti | 16 Laudani & Romanelli | 24 Matteo Ragni | |



a brand of **euro3plast spa**

Viale del Lavoro, 45 - 36021
Ponte di Barbarano (VI) - Italy
T +39 0444 788200
F +39 0444 788290
www.plust.com
info@plust.com

Art Direction: Studio JoeVelluto (JVLT)

Main photographer: Riccardo Urnato

Other photographers: Lorenzo Ceretta pag. 106, 136, 153, 167; others pag. 4, 20, 137, 172, 176, 220, 258

Printed by: Campisi - Aprile / Aprile 2016



Le immagini e i dati riportati in questo catalogo sono indicativi. **Euro3plast spa** si riserva il diritto di apportare eventuali variazioni o migliorie agli articoli illustrati, anche senza preavviso. I nostri uffici commerciali rimangono a vostra completa disposizione per qualsiasi ulteriore delucidazione.
The images and the indicated data in our catalogue are approximate. Euro3plast spa reserves the right to effect any changes or improvements, to the illustrated articles, also without notice. For further information, our trade departments are at your disposal.

Tutte le misure sono espresse in centimetri.
All measures are understood in centimeters.



PLUS+[®]
PLUSTCOLLECTION

a brand of **euro3plast spa**

Viale del Lavoro, 45 - 36021
Ponte di Barbarano (VI) - Italy
T +39 0444 788200
F +39 0444 788290
www.plust.com
info@plust.com